

BLACHERE ILLUMINATION 2025

GENERAL *catalog*





HEAD OFFICE & WORKSHOP

Blachere Illumination S.A.S
22 Allée des Bourguignons, 84400, Apt
Tel : + 33 (0) 413 068 004
Fax : + 33 (0) 490 741 463

Mail : sales@blachere-illumination.com
Web : blachere-illumination.com

DESIGN • DESIGN DPT BLACHERE

CONTACT

Géraldine - tél : +33 (0) 490 747 323
geraldine@blachere-illumination.com
Léa - tél : +33 (0) 490 747 642
Lalves@blachere-illumination.com
Marion - tél : +33 (0) 490 747 330
marion@blachere-illumination.com
Irène - tél : +33 (0) 490 747 396
i.baravet@blachere-illumination.com
Marie - tél : +33 (0) 490 747 044
marie@blachere-illumination.com
Cathy - tél : +33 (0) 490 747 325
cathy@blachere-illumination.com

COVER • DESIGN DPT BLACHERE

PHOTOGRAPHERS

- Michel Djaoui
- Lionel Moulet
- Jérémie Pitot
- Odile Pascal
- Brice Toul
- Eric Soltan
- Camille Moirenc

PRINT • GROUPE PRENANT

ALL RIGHTS RESERVED

Not a contract document. The sizes and wattages of motifs may be subject to change for technical reasons.
Non-contractual images.

All our products are CE marked meaning that they meet electrical security norms and electromagnetic requirements.
All our motifs, designs and graphics are protected by the INPI, the OMPI and current industrial and intellectual property laws.
Reproduction of any kind, in full or part, is strictly forbidden without written authorisation of blachere illumination s.a.s.

Get inspired at blachere-illumination.com



SUMMARY

catalogue

1	VOLUMES & URBAN	14 – 71
2	SUSPENSIONS COLLECTIONS	72 – 157
3	GARLANDS	158 – 227
4	DECORATIONS	228 – 253
5	TECHNICAL PAGES	254 – 288

◆ Height

◆ Length

▣ Width

⚡ Voltage

⚖ Weight

☀ Flash colour

● LED colour

■ Print colour

Ⓝ News

♻ Recycled bottles needed to create a decoration

OUR HISTORY

It all began in Apt, in the heart of Provence, in 1973.

When Jean-Paul Blachère illuminated his first village, the smiles on the inhabitants' faces were his confirmation that light has a unique magical power. He then turned this experience into a profession, a passion and know-how that he passes on with love and respect for tradition.

We have now grown, delivering our decorations in over 80 countries, supported by our 600 members of staff in France and our 27 subsidiaries worldwide. We are proud to illuminate 70% of French districts with over 5,000 inhabitants and more than 1,000 towns and cities and 500 shopping centres worldwide.

Above all, we strive to do our job with the same passion as on the very first day.

The richness of our company comes from the experience gained through discussions, listening and the creative solutions provided for our customers.

When it comes to illuminations in Sweden, the United States, France or Mexico, the expectations are often different. The adaptability and professionalism of our local teams therefore ensure that we are able to meet the needs of each city and the culture of each country.

The ultimate aim, whatever the location around the globe, is to arouse emotions with our illuminations...

-
- 27 SUBSIDIARIES
 - 1000 TOWNS AND CITIES ILLUMINATED IN OVER 80 COUNTRIES
 - 800 SHOPPING CENTRES WORLDWIDE
-



BLACHERE KNOW-HOW

For us, creation is key: it starts with a sketch, a drawing by hand, an idea, a dream... then our designers bring it to life in the form of light. We are more than just manufacturers; we are passionate creatives with a single mission: to enthral the world by telling beautiful stories through fairytale designs, innovative decorations and magical luminous settings.

We are inspired by all that surrounds us, and by anything that could stir an emotion... Being creative is not mutually exclusive with professional expertise: this philosophy keeps us one step ahead and sets us apart from the crowd. Thanks to our innovations, we are able to strike the right balance between age-old know-how and industrialisation.

This is demonstrated by the fact that we are the only company in our market to have received the EPV living heritage company label.

-
- 12 LARGE-SCALE 3D PRINTERS
 - 5 PRODUCTION SITES AROUND THE WORLD
 - 500 PEOPLE IN OUR FRENCH AND INTERNATIONAL WORKSHOPS
-

This distinction is awarded to companies with exceptional know-how, combining tradition and innovation.

From decorative ironwork to the most painstaking wiring, more than 7,000 made-to-measure decorations take shape in our workshops in France and abroad each year: the "Haute Couture" of illuminations. In parallel, standard decorations from our summer and winter "Ready-to-wear" collections are printed using eco-friendly materials thanks to our fleet of twelve large-scale 3D printers in France and elsewhere.

Although our expertise was born in France over 50 years ago, we are delighted to now have five production sites in Europe, the Middle East and America, which allow us to deliver to countries around the world via local supply chains and to contend with the economic demands of the market.



OUR LARGE-SCALE 3D PRINTERS

We will never stop innovating in order to rise to the new ecological challenges with creativity and common sense.

Each year, we do everything in our power to create or replace parts of our decorations to make them more eco-friendly and limit their impact as much as possible. Thanks to our fleet of 12 large-scale 3D printers, since 2016 we have been printing structures in eco-friendly materials, thereby replacing 80% of the aluminium in our decorations.

Whether we are working with Bioprint, Recyprint or our brand-new Flexiprint, the operating

procedure is the same: the granules of these three materials are tinted with clean dyes and then injected into our 3D printers to produce coloured structures.

Our manufacturing processes are patented.

This innovation has enabled the creation of a workshop dedicated to 3D printing, along with a dozen jobs, most of which are new professions within our group.



BIOPRINT



Bioprint is a bio-based material derived from GM-free sugar cane turned into dehydrated bioethanol under the supervision of a French laboratory. Our Bioprint decorations are reused or recycled at the end of their life, and remain biodegradable if they are thrown away. Biodegradation is the breakdown of organic materials by microorganisms, without causing damage to the natural environment.

- **• BIOBASED, MADE FROM SUGAR CANE**
- **• 100% BIODEGRADABLE AND RECYCLABLE**



RECYPRINT



600 billion bottles are produced each year, and many of them end up in the oceans. At Blachere, we have decided to turn this waste into magical decorations. The plastic bottles collected are recovered by specialist bodies, which recycle them.

This post-consumer recycled plastic from the food industry is then injected into our printers in the form of granules. Over four million bottles have already been turned into decorations to date.

- **• MADE FROM PLASTIC BOTTLES**
- **• 100% RECYCLABLE**



FLEXIPRINT



Following on from Bioprint and Recyprint, this year we have created Flexiprint with the same aim of reducing our products' impact and adopting a sustainable and ecofriendly approach.

After months of tests, we are now offering a unique material made from recycled plastic that is supple enough to cover our three-dimensional decorations, like textile or mesh. This new material therefore now adorns our figures or Christmas trees, supplementing our ranges of sustainable and eco-friendly products.

- **• MADE FROM RECYCLED PLASTIC**
- **• 100% RECYCLABLE**





Antwerpen, Belgium



The Shard, London, United Kingdom

OUR SCHEMES



Victoria Leeds, United Kingdom



Ikuna Resort, Natterbach, Austria



Malines/Mechelen, Belgium



The Shops at Columbus Circle, New-York, USA

OUR SCHEMES



Amsterdam, The Netherlands



La Perla, Mexico

OUR ECO-FRIENDLY MATERIALS

Innovation has always been in our DNA. As our company was born in 1973 at the heart of the oil crisis, we have been continually developing the construction of our decorations since our company was founded to make them more eco-friendly and limit their impact as much as possible.

Every year, more than 35,000 decorations are restored and reconditioned to be hired out or resold once more. We also put in place measures to encourage a clean end of life for all our products.

RECYCLED ALUMINIUM

The frameworks and support structures of our decorations are made of aluminium, composed of 70% recycled material.

ECO-FRIENDLY MATERIALS



OUR COLOURS AVAILABLE



LOW-CONSUMPTION LEDS

Our decorations and all the products in the fairy lights and spotlights section are equipped with ultra-low consumption LEDs that consume ten times less energy than traditional lighting.

SOLAR POWER ALTERNATIVE

To respond to your ecological concerns with creativity and common sense, certain decorations are available with solar panels, making them totally self-sufficient.

CONTROLLING YOUR DECORATIONS

Smart energy management is an integral part of a global eco-friendly urban policy. To be able to control your illuminations as best as possible, we offer you a range of boxes as well as complete control systems, which can be found in the accessories section at the end of the catalogue.

CLEAN END OF LIFE FOR DECORATIONS

At Blachere, we ensure:

- The repair, reuse, collection and processing of waste electrical and electronic equipment.
- Bioprint, Recyprint and Flexiprint are recyclable and repurposed.



SUSTAINABILITY AND RECONDITIONED DECORATIONS

At Blachere, it is essential to look after things and take a long-term approach. We don't throw away, we repair!

We give our decorations a new lease of life – sometimes more than once – and offer our clients a broad range of fully serviced and reconditioned decorations: an ecoaware and responsible mode of consumption with decorations that remain of high quality and attractively priced.

Our servicing process stretches from January to June. 50 to 60 people are enlisted in our workshops to repair 35,000 decorations per year, whether they are lamppost decorations, figures

or fairy lights.

The decorations are carefully tested and repaired one by one, by hand, according to extremely exacting repair and servicing criteria.

The most sensitive products are then stored on racks in our covered warehouses, and the others in our outdoor area. Just under three hectares in total is dedicated to storing these decorations.

Our sales team remains at your disposal to present our full range of reconditioned decorations.

Long live Blachere Illumination decorations!

-
- 35,000 DECORATIONS SERVICED EACH YEAR
 - EXTREMELY EXACTING SERVICING AND REPAIR CRITERIA
 - A FULL RANGE OF RECONDITIONED DECORATIONS
-



OUR COMMITMENTS TO CSR, LABELS & QUALITY

We keep our communication short but truthful. Our CSR approach is in keeping with our attitude for the past 50 years. Everything that we create to light up the world absolutely must respect our planet and care for humanity.

We are keen to create a working environment that allows every employee to flourish. We like to develop, train and support our staff, to make them want to stay, while offering them the chance to advance and learn. For us, gender equality and equal opportunity are the keys to success, and we are proud to employ almost as many women as men in our teams.

Social and professional integration offers multiple opportunities for people with disabilities or the long-term unemployed.

Boasting ISO 9001 certification experience for 12 years, we have now decided to develop our own quality criteria, tailored to our market and specific to the constraints of our unique profession.

The goal to be achieved is key, but how we achieve it is even more so! Come and visit us and you'll see!



Living Heritage Company (EPV) is an official French label delivered under the authority of the Ministry of the Economy and Finance, to designate French companies with artisanal and industrial expertise deemed exceptional.



Launched in 2000, the United Nations Global Compact is the largest global initiative in terms of social responsibility. We signed up to the compact in 2023, and incorporate the principles regarding human rights, international labour standards, environmental protection and fighting all forms of corruption into our strategy.



The French Touch is an inspiring and inspired movement created to support the economic growth of cultural and creative industries. The French Touch brings together companies in the sector to form a network of motivated and determined entrepreneurs united around four core values: creativity, excellence, boldness, and authenticity.



Launched in 2017, La French Fab flies the flag for French industry in motion. La French Fab represents companies, economic players, institutions and industrial sites located in France who want to develop French industry.



The Le Coq Vert community is THE community of companies committed to the energy and ecological transition. This logo demonstrates our commitment to putting climate concerns at the heart of our strategy.



This label showcases companies involved in the circular economy. It is awarded to manufacturers that introduce recycled plastic materials into their production.

THE BLACHERE FOUNDATION

The fruit of a passion for contemporary art and the African continent, our corporate foundation was established by Jean-Paul Blachère in 2004.

It supports contemporary art from Africa and the promotion of artists from the African continent.

In its 400m² arts centre at the heart of the Luberon region, it presents exhibitions

and welcomes artists in residence in France and Africa. It takes part in major African biennales, notably the Dakar Biennale.

Since its creation, over 500 male and female, unknown or renowned artists have stepped through the door opened by the Foundation into the vast world of contemporary art.



COMMON SENSE AND KINDNESS ARE AT THE HEART OF OUR BEHAVIOUR IN THE BLACHERE GROUP





VOLUMES & URBAN

GENERAL CATALOGUE



GX346L

GX354LW

SL051W

GX348L

GX356L

SL053W



N GX356L- ICE
 1.8m 1.5m 1.0m 31kg 32W
 FLASH

N GX346L- TIPI CRISTAL
 2.3m 1.2m 1.2m 30kg 65W
 FLASH

N SL053W- KADO
 1.3m 0.8m 0.8m 15kg 12W

N GX354LW- LUX
 3.7m 3.6m 3.6m 155kg 210W
 SOFT XLED

N SL051W- FONTAIN CRISTAL
 2.8m 4.0m 4.0m 56kg 182W
 SOFT XLED

N GX348L- SANTA CRISTAL
 2.9m 1.9m 1.4m 70kg 40W
 FLASH



N	GX347L-WIZZ CRISTAL			
	1.2m	1.2m	2.3m	69.5kg 90W
	FLASH			

N	GX349L-FROST			
	1.5m	2.6m	1.1m	46kg 40W
	FLASH			

N	GX344L-SCALA			
	5.0m	3.0m	3.0m	155kg 150W
	FLASH			

N	SL052W-DEMI ARCHE CRISTAL			
	2.5m	1.0m	1.0m	23kg 52W
	FLASH	49		

N	GX357L-CHRIS			
	2.5m	1.5m	1.0m	44kg 44W
	FLASH			

N	GX345L-CRISTAL			
	3.1m	2.1m	1.2m	50kg 70W
	FLASH			



SL053W

GX333L



SL053W-KADO

◆ 1.3m	◆ 0.8m	◆ 0.8m	▲ 15kg	↻ 12W
--------	--------	--------	--------	-------



GX333L-HAPPY SANTA

◆ 2.6m	◆ 2.5m	◆ 1.5m	▲ 96kg	↻ 64W
--------	--------	--------	--------	-------

■	●	●	●	●	FLASH	5
---	---	---	---	---	-------	---



GX087L

GX265LW

GX163L

GX087L-LITTLE TEDDY CHIC

◆ 2.0m	◆ 2.0m	◆ 1.5m	▲ 54kg	↻ 40W
--------	--------	--------	--------	-------

●	●	●	●	●	FLASH
---	---	---	---	---	-------

GX265LW-LOLLIPOP

◆ 2.0m	◆ 1.3m	◆ 1.3m	▲ 31.5kg	↻ 50W
--------	--------	--------	----------	-------

●	●	●	●	●	FLASH
---	---	---	---	---	-------

GX163L-ELIOTT

◆ 2.8m	◆ 2.0m	◆ 1.3m	▲ 32kg	↻ 20W
--------	--------	--------	--------	-------

●	●	●	●	●	FLASH
---	---	---	---	---	-------

SV504A



GX308L

GX148L

GX308L-LETTERBOX
 ◆ 2.0m ◀ 0.9m ▶ 0.9m ⚖ 43.5kg ⚡ 172W
 ● STARSFLASH

SV504A-DAVE A
 ◆ 3.1m ◀ 1.6m ▶ 1.6m ⚖ 44.5kg ⚡ 35W
 ● FLASH

GX148L-MAX
 ◆ 2.2m ◀ 1.8m ▶ 1.4m ⚖ 28.5kg ⚡ 33W
 ● FLASH



GX132L



GX153L

SL038W

GX153L-CANDY SELFIE
 ◆ 2.0m ◀ 1.9m ▶ 1.0m ⚖ 59kg ⚡ 39W
 ● STARS&FLASH

GX132L-MISTER XMAS
 ◆ 3.6m ◀ 2.6m ▶ 1.9m ⚖ 97kg ⚡ 74W
 ● ● ● ● ● 5

SL038W-KDO
 ◆ 1.3m ◀ 0.9m ▶ 0.9m ⚖ 17.5kg ⚡ 20W
 ● ● 25

SL038B-KDO
 ◆ 1.3m ◀ 0.9m ▶ 0.9m ⚖ 17.5kg ⚡ 20W
 ● ● 25

SL038R-KDO
 ◆ 1.3m ◀ 0.9m ▶ 0.9m ⚖ 17.5kg ⚡ 20W
 ● ● 25



GX261LW-TRADI BOX
 ◆ 1.9m ◆ 1.2m ◆ 0.7m ◆ 32.5kg ◆ 60W
 ● ● FLASH&STARS 9

GX092L-CUTE RENNOO
 ◆ 2.0m ◆ 1.2m ◆ 0.7m ◆ 99kg ◆ 18W
 ● ● FLASH

GX093L-RENNOO
 ◆ 2.0m ◆ 1.2m ◆ 0.6m ◆ 52kg ◆ 18W
 ● ● FLASH



GX260LW-ELY
 ◆ 1.6m ◆ 1.2m ◆ 1.0m ◆ 71kg ◆ 20W
 ● ● STARS 41

SOCL43-ASTRAL BOOTH
 ◆ 2.2m ◆ 2.0m ◆ 0.8m ◆ 20.4kg ◆ 25W
 ● ● 118

SL038W-KDO
 ◆ 1.3m ◆ 0.9m ◆ 0.9m ◆ 17.5kg ◆ 20W
 ● ● 25



SOCL47

GX151L

GX152L

GX151L-ROY
 ◆ 2.0m ◆ 1.0m ◆ 1.0m ◆ 27kg ◆ 17W
 FLASH

SOCL47-TRADI PHOTOBOOTH
 ◆ 2.5m ◆ 1.8m ◆ 0.8m ◆ 11.5kg ◆ 15W
 FLASH

GX152L-ED
 ◆ 2.0m ◆ 1.5m ◆ 0.9m ◆ 27.5kg ◆ 12W
 FLASH



2 in 1 products!
 You can choose from a warm white or pure white.
 By reversing the connectors, you can obtain either a pure white decor/ pure white flash or a warm white decor/warm white flash.



GX194L

GX118DC

GX194L-WIZZ
 ◆ 1.2m ◆ 2.3m ◆ 1.2m ◆ 82kg ◆ 79W
 XLEDSTARSFLASH 277

GX118DC-DUO COMETE
 ◆ 2.6m ◆ 2.2m ◆ 1.2m ◆ 27.4kg ◆ 35W
 FLASH



GX263L

GX358L

GX267LW

GX102LW

GX247L-A

GX264LW

GX193L

GX244L

GX263L-THEODOR

◆ 2.3m ◆ 0.9m ▫ 1.1m ▲ 25.5kg ↻ 20W

● ● FLASH 3

GX358L-ALEX

◆ 1.7m ◆ 2.4m ▫ 1.9m ▲ 72kg ↻ 91W

● ● FLASH&STARS

GX267LW-CIRCUS

◆ 3.0m ◆ 1.8m ▫ 1.8m ▲ 81kg ↻ 160W

● ● FLASH 32

TO ORDER

GX102LW-XMAS TRAIN

◆ 1.9m ◆ 3.6m ▫ 1.0m ▲ 130kg ↻ 124W

● ● FLASH&XLED 33

TO ORDER

GX247L-A-BOX

◆ 2.2m ◆ 1.7m ▫ 0.9m ▲ 81.5kg ↻ 150W

● ● STARS&XLED 586

GX264LW-BIGS

◆ 1.6m ◆ 1.9m ▫ 0.8m ▲ 67.5kg ↻ 75W

● ● FLASH 519

GX193L-FLASH

◆ 1.3m ◆ 2.4m ▫ 1.0m ▲ 42.5kg ↻ 45W

● ● FLASH&XLED&STARS

GX244L-LOLITA

◆ 2.3m ◆ 2.1m ▫ 1.6m ▲ 53kg ↻ 35W

●





GX262LW-YUMMY
 ◆1.6m ◆1.3m ▣0.3m 🧑17kg ⚡35W
 🟡 🟢 🟠 FLASH 192

GX159L-DOUDOU
 ◆2.1m ◆1.9m ▣1.2m 🧑39.5kg ⚡28W
 🟡 🟢 🟠 FLASH

GX248LR-SUGAR
 ◆2.0m ◆0.8m ▣0.8m 🧑27.5kg ⚡5W
 🟡 🟢 FLASH



GX105L-TOMMY
 ◆2.7m ◆2.5m ▣2.2m 🧑91kg ⚡50W
 🟡 🟢 🟠 FLASH

GX164L-WIZZ SANTA
 ◆2.3m ◆1.8m ▣1.2m 🧑66kg ⚡25W
 🟡 🟢 🟠 FLASH

GX119L-ROMY
 ◆1.5m ◆3.0m ▣2.45 🧑81.0kg ⚡29W
 🟡 🟢 FLASH

GX118L-COMETE
 ◆2.6m ◆2.2m ▣1.2 🧑27.4kg ⚡14W
 🟡 🟢 FLASH

GX249L-RAYMOND
 ◆2.2m ◆1.5m ▣0.8m 🧑37kg ⚡20W
 🟡 🟢 FLASH
GX249L-A-RAYMOND
 ◆2.2m ◆1.5m ▣0.8m 🧑44kg ⚡20W
 🟡 🟢 FLASH
 With push button



GX086L / GX086L-A



SL135W

GX133L



GX097L



SL045V



GX098L



GX086L- TEDDY CHIC

◆ 4.0m ◆ 4.0m ◆ 2.8m ▲ 157kg ↻ 208W

FLASH

TO ORDER

GX086L-A- TEDDY CHIC

◆ 4.0m ◆ 4.0m ◆ 2.8m ▲ 172kg ↻ 248W

INTERACTIVITE & FLASH

TO ORDER

With presence detector

SL135W- ASTRAL ARCH

◆ 2.8m ◆ 1.8m ◆ 1.4m ▲ 88kg ↻ 80W

FLASH & XLED 25

GX133L- MISTER SANTA

◆ 2.8m ◆ 1.8m ◆ 1.4m ▲ 125kg ↻ 46W

FLASH 5

GX097L- PETER

◆ 2.0m ◆ 1.3m ◆ 0.6m ▲ 60kg ↻ 20W

FLASH 5

SL045V- VERDE

◆ 3.0m ◆ 2.3m ◆ 2.3m ▲ 45.5kg ↻ 180W

XLED 299

GX098L- JOHN

◆ 2.3m ◆ 1.5m ◆ 0.9m ▲ 56kg ↻ 30W

FLASH 5





GX262LW-YUMMY

1.6m	1.3m	0.3m	17kg	35W
FLASH	192			

GX256LW-ANGEL

1.8m	1.6m	0.3m	21kg	55W
FLASH	22			

GX257LW-CLEM

1.5m	1.2m	0.3m	17.5kg	30W
FLASH	191			

GX172LW-JOSÉ

2.2m	1.2m	0.3m	15kg	40W
FLASH	57			

GX259LW-CLEO

1.5m	1.3m	0.3m	21kg	50W
FLASH	184			

GX245LW-MANALA

1.9m	1.3m	0.3m	19.5kg	45W
FLASH	258			

GX258LW-KRYS

1.2m	1.3m	0.3m	17kg	55W
FLASH	172			

GX350LW-SCENETTE JOSÉ

2.0m	2.4m	0.5m	36kg	85W
XLED	257			





GX047L-SKATE BEAR
 ◆2.3m ◆2.0m ▣1.1m 🧑 44kg ⚡ 30W
 🇮🇹

GX182L-TEDDY SKI
 ◆4.0m ◆3.4m ▣2.6m 🧑 148kg ⚡ 146W
 🇮🇹 XLED 📶 41

GX160L-PINGU
 ◆2.1m ◆1.9m ▣1.2m 🧑 31kg ⚡ 20W
 🇮🇹 FLASH 📶 15

GX182L-A-TEDDY SKI ANIME
 ◆4.0m ◆3.4m ▣2.6m 🧑 160kg ⚡ 186W
 🇮🇹 🇪🇺 interactivitéXLED 📶 41

SOCL42-BLIZZARD PHOTOBOOTH
 ◆2.2m ◆1.6m ▣0.8m 🧑 18.5kg ⚡ 25W
 🇮🇹 📶 142

GX206L-BABY BEAR
 ◆1.5m ◆1.4m ▣1.3m 🧑 30.4kg ⚡ 40W
 🇮🇹

GX145L-NOAH
 ◆3.0m ◆2.3m ▣1.8m 🧑 76kg ⚡ 54W
 🇮🇹 FLASH&XLED 📶 21

GX205L-DADDY BEAR
 ◆1.5m ◆2.2m ▣0.7m 🧑 27kg ⚡ 22W
 🇮🇹

GX149L-FROZEN LETTERBOX
 ◆2.0m ◆1.1m ▣1.1m 🧑 36kg ⚡ 49W
 🇮🇹 🇪🇺 STARS&FLASH 📶 432

GX079L-ICE IGLOO
 ◆1.5m ◆2.2m ▣2.0m 🧑 55kg ⚡ 64W
 🇮🇹 FLASH 📶 134

GX147L-FOX
 ◆2.2m ◆1.8m ▣1.4m 🧑 37kg ⚡ 20W
 🇮🇹 FLASH

With presence detector
 TO ORDER

GX145L-A-NOAH ANIME
 ◆3.0m ◆2.3m ▣1.8m 🧑 100kg ⚡ 54W
 🇮🇹 INTERACTIVITE&FLASH&XLED 📶 21
 + buzzer
 TO ORDER



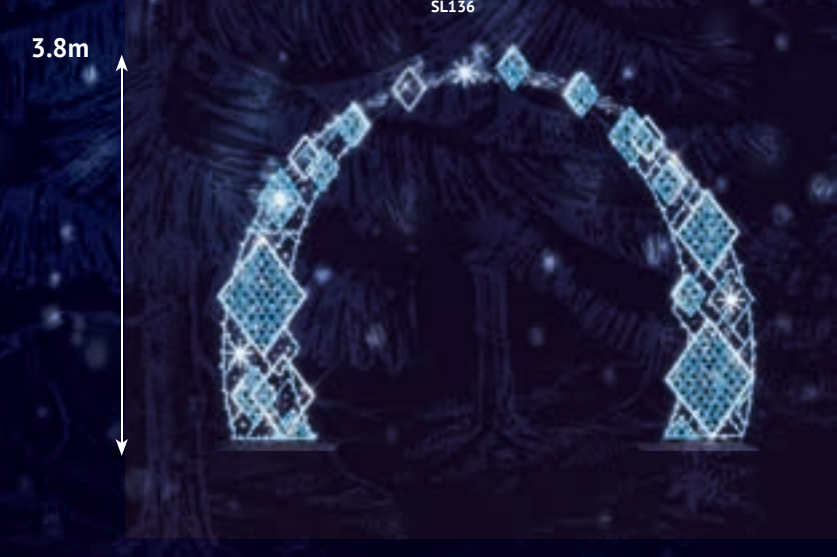
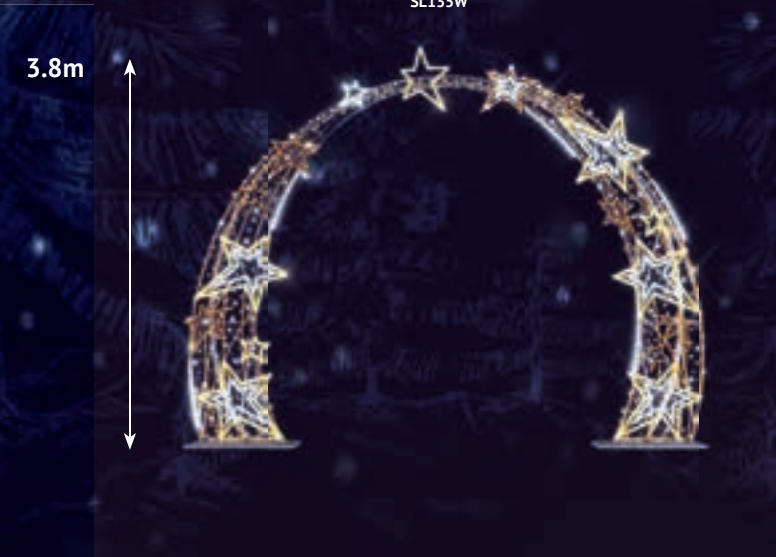
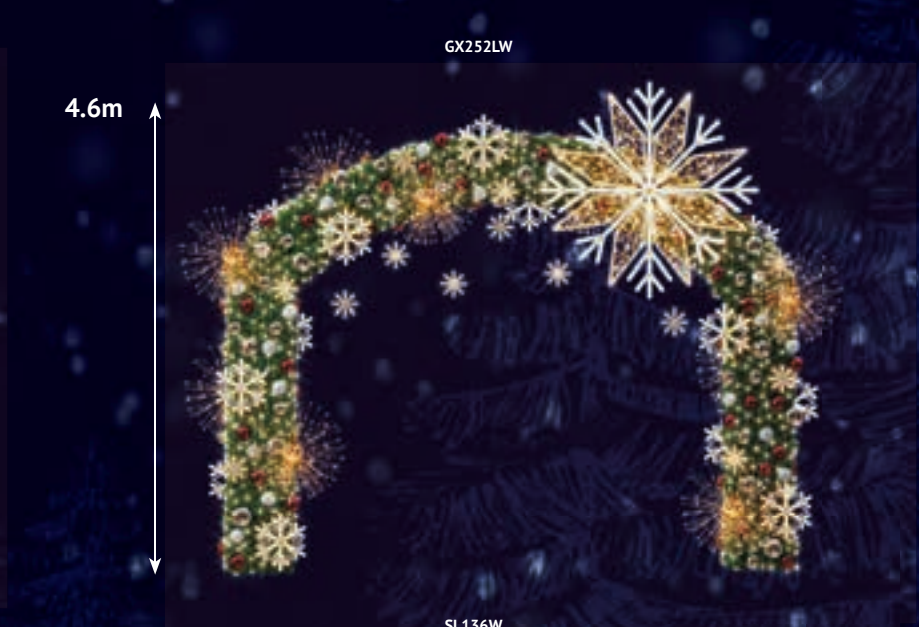
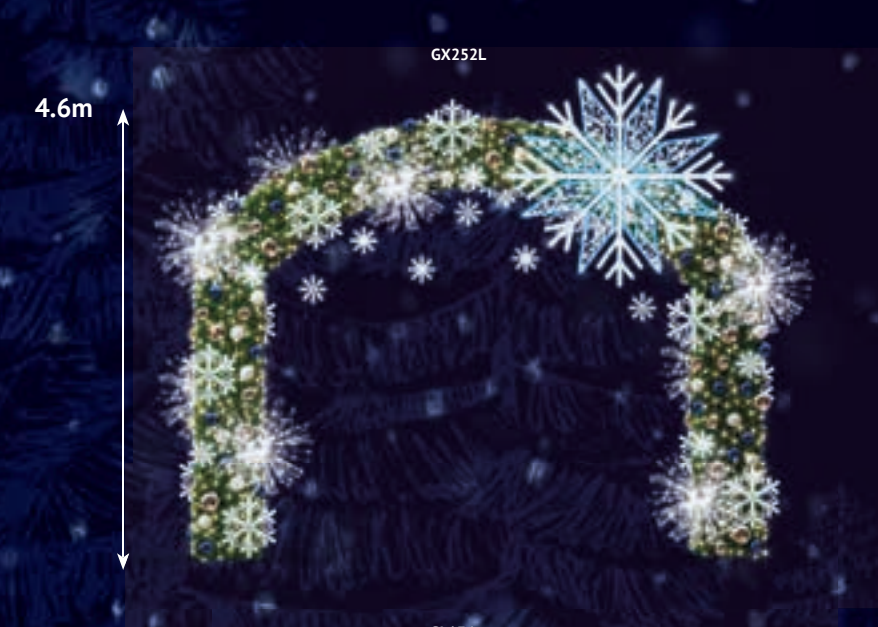
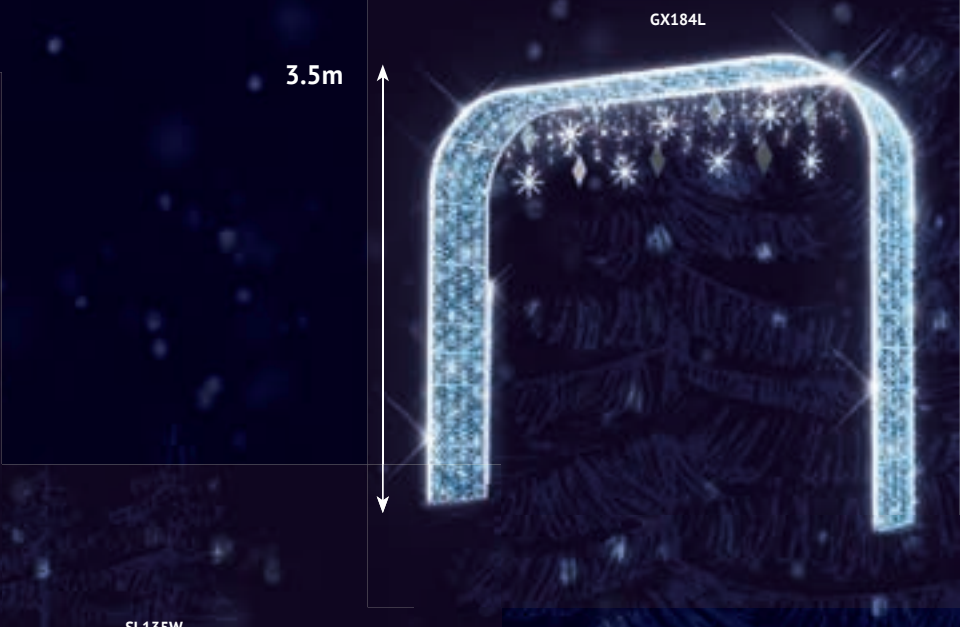
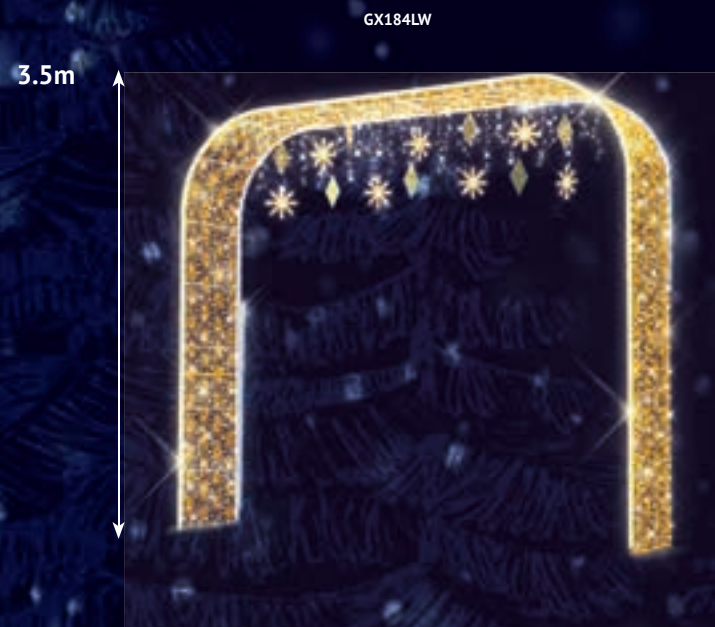

GX184LW- GOLD ARCH
 ◆ 3.5m ◆ 5.8m ▮ 1.0m 🏠 115kg ⚡ 100W
 🟡 🟡 FLASH & FL900E&COMETE 337
 TO ORDER

SL135W- ASTRAL ARCH
 ◆ 3.8m ◆ 4.9m ▮ 1.0m 🏠 88kg ⚡ 80W
 🟡 🟡 FLASH & XLED 25
 TO ORDER

GX184L- BLIZZARD ARCH
 ◆ 3.5m ◆ 5.8m ▮ 1.0m 🏠 115kg ⚡ 100W
 🔵 🔵 FLASH & FL900E&COMETE 337
 TO ORDER

GX252L- TRADI ARC
 ◆ 4.6m ◆ 5.9m ▮ 1.0m 🏠 382kg ⚡ 568W
 🔵 🔵 STARS&FLASH 25
 TO ORDER
SL136- QUADRILLE ARCH
 ◆ 3.8m ◆ 4.9m ▮ 1.0m 🏠 81.5kg ⚡ 60W
 🔵 🔵 XLED & FL900E&FLASH 25
 TO ORDER

GX252LW- TRADI ARC
 ◆ 4.6m ◆ 5.9m ▮ 1.0m 🏠 382kg ⚡ 568W
 🟡 🟡 FLASH&STARS 25
 TO ORDER
SL136W- QUADRILLE ARCH
 ◆ 3.8m ◆ 4.9m ▮ 1.0m 🏠 81.5kg ⚡ 60W
 🟡 🟡 XLED&STARS&FLASH 25
 TO ORDER



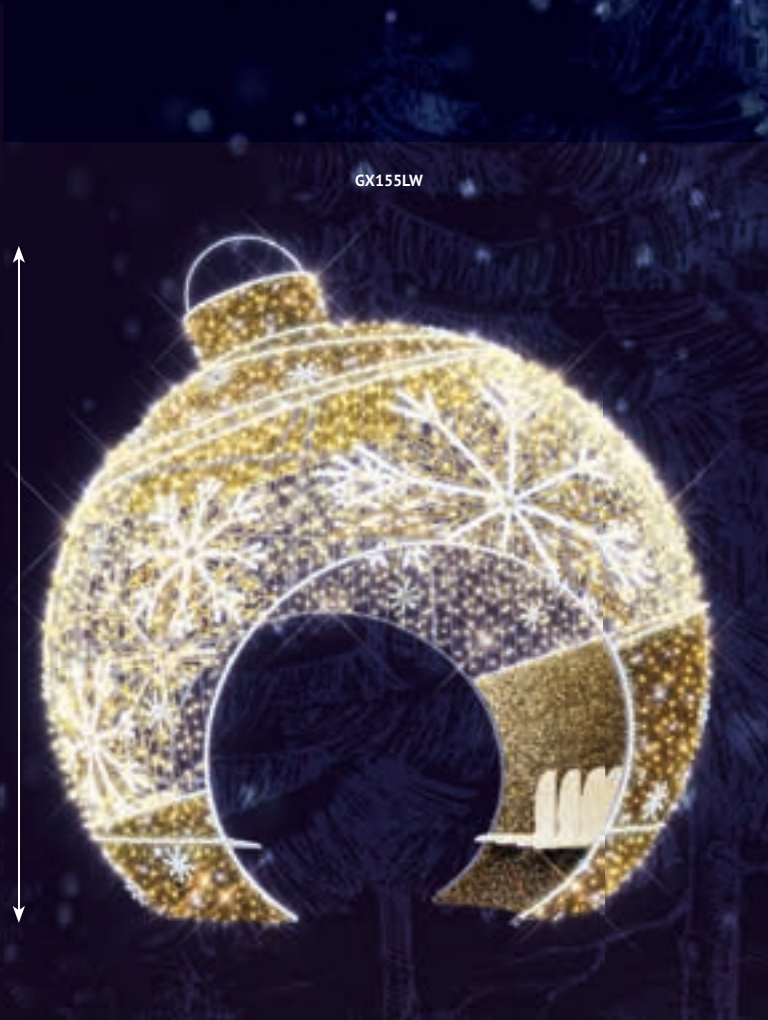

SL050R- LOVE ARCH

5.0m 1.0m 1.5m 219kg 150W

832

TO ORDER

GX155LW-ELIE

4.2m 4.0m 4.0m 386kg 382W

STARS & FLASH 441

GX154LW- LUMI

4.0m 2.0m 1.8m 171kg 135W

FLASH 1367

GX070LR- TITAN

3.9m 3.6m 3.3m 235kg 260W

FLASH 1927

TO ORDER

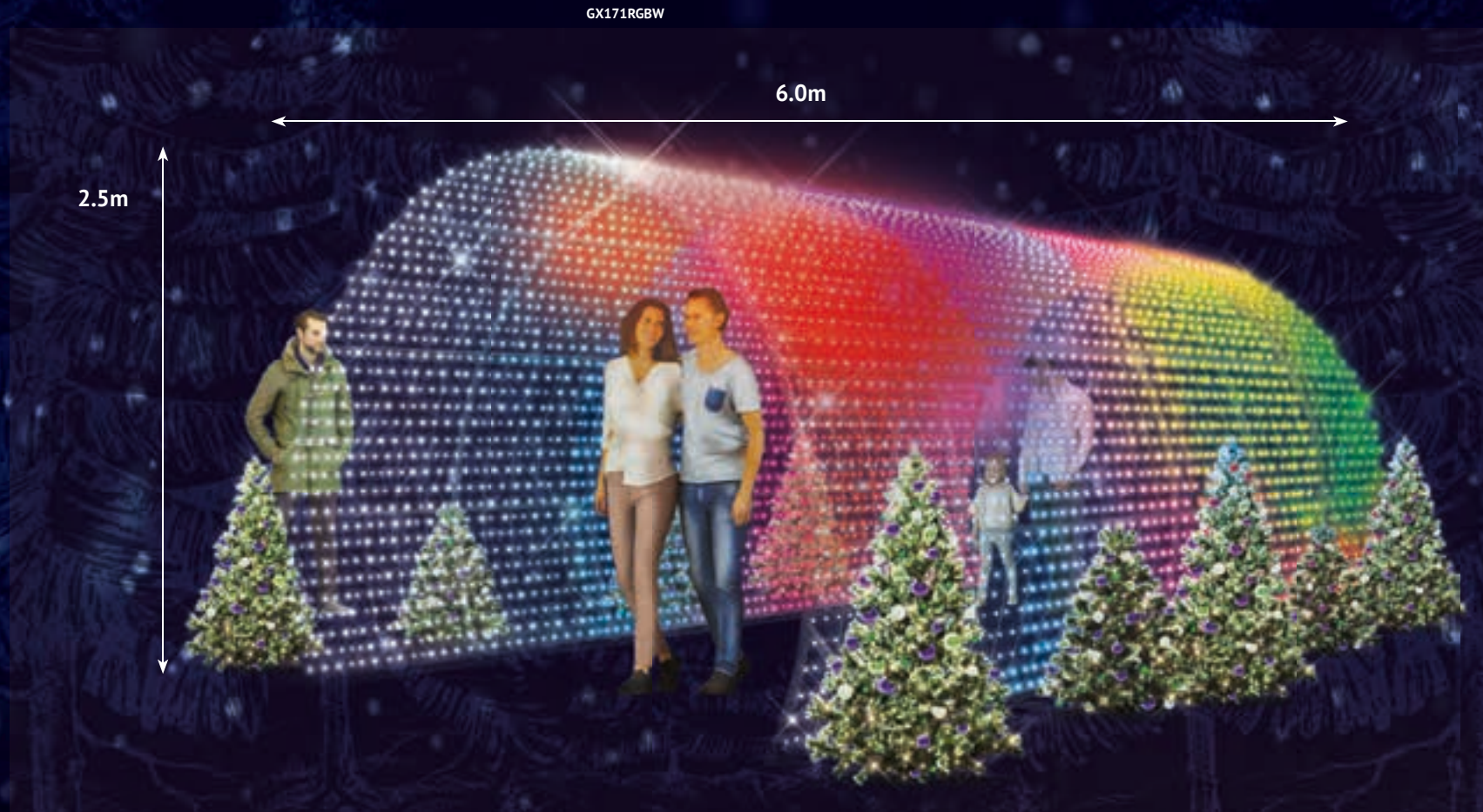
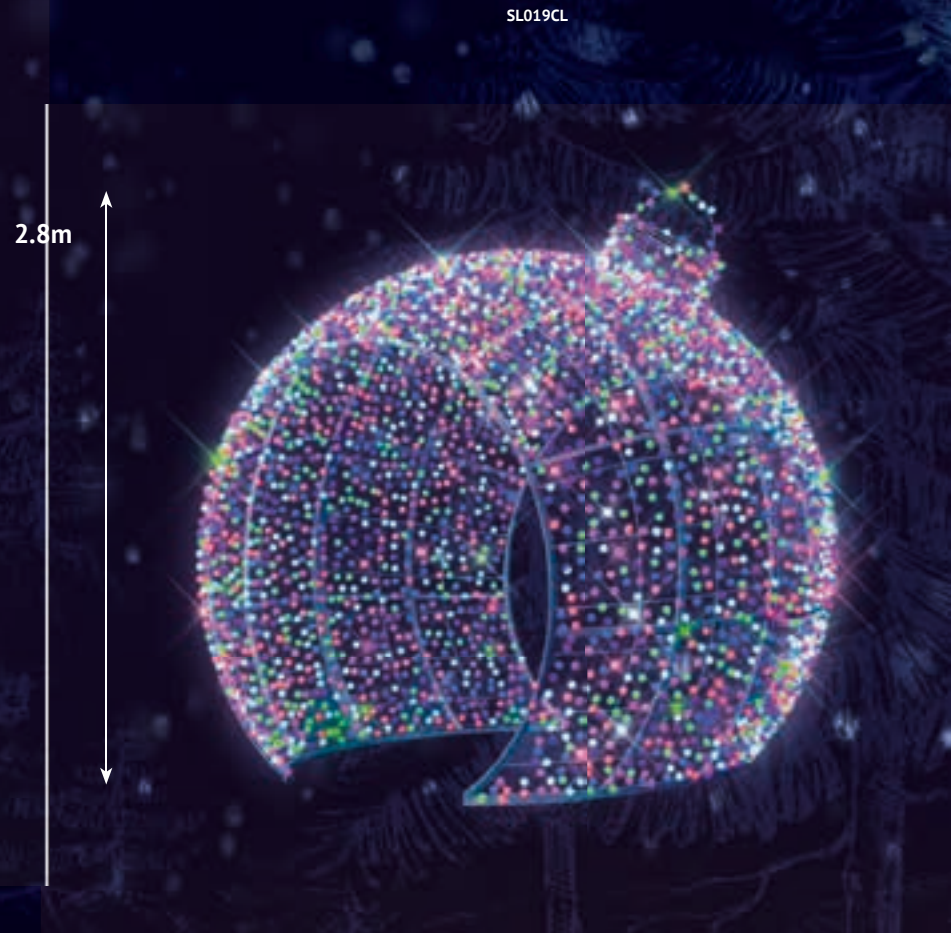

GX070CL- CHERRY BOX
 3.9m 3.6m 3.3m 235kg 175W
 FLASH&RGBWW 1927
 TO ORDER

SL019CL- CHERRY BALL
 2.8m 3.0m 2.2m 143kg 58W
 RGBWW
 TO ORDER

GX171RGBW- FUTURA
 2.5m 6.0m 4.4m 257.6kg 600W
 RGBWW
 TO ORDER



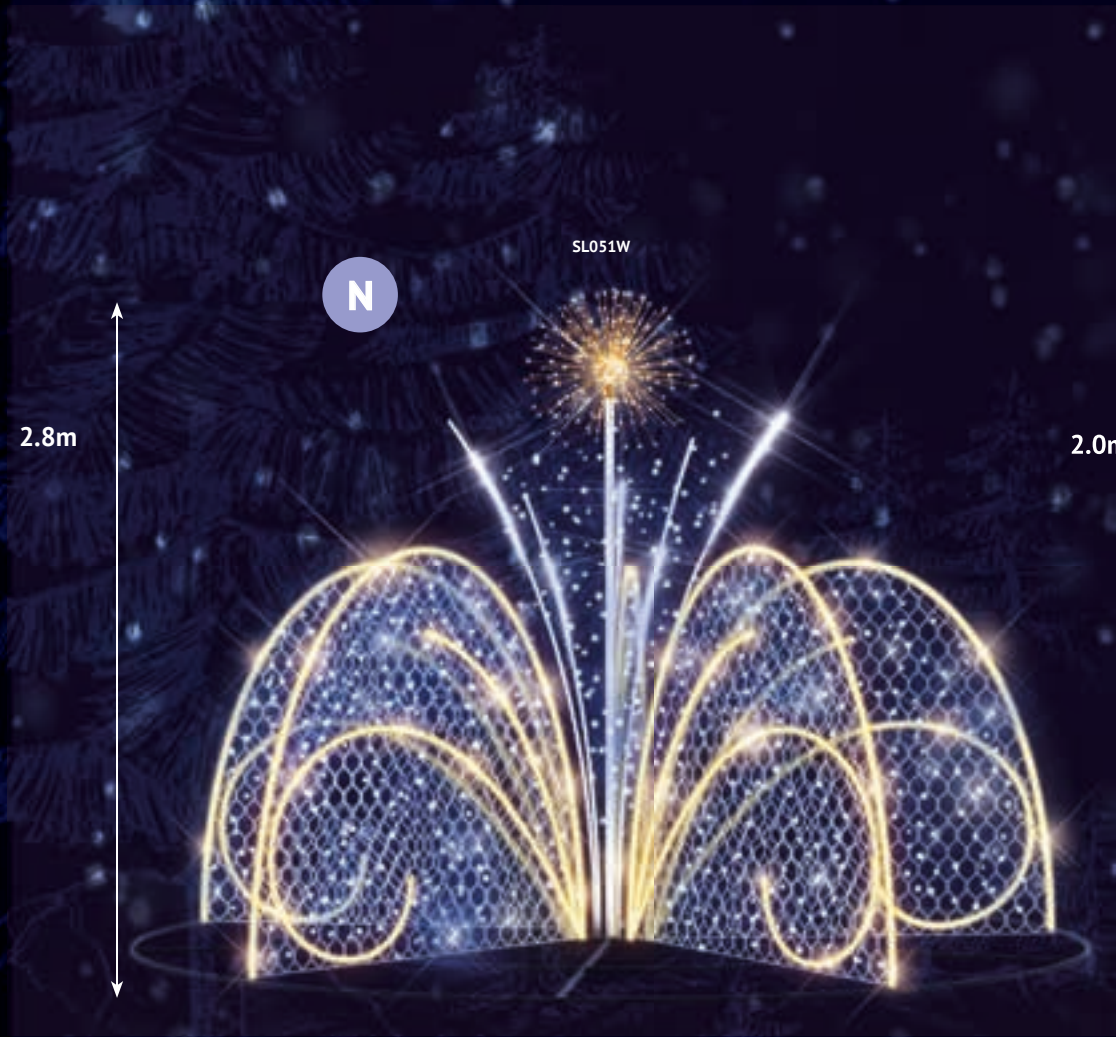

SL051W-FONTAIN CRISTAL
 ◆ 2.8m ◆ 4.0m ◆ 4.0m ⚖️ 56kg ⚡ 182W
 ● SOFT XLLED 257

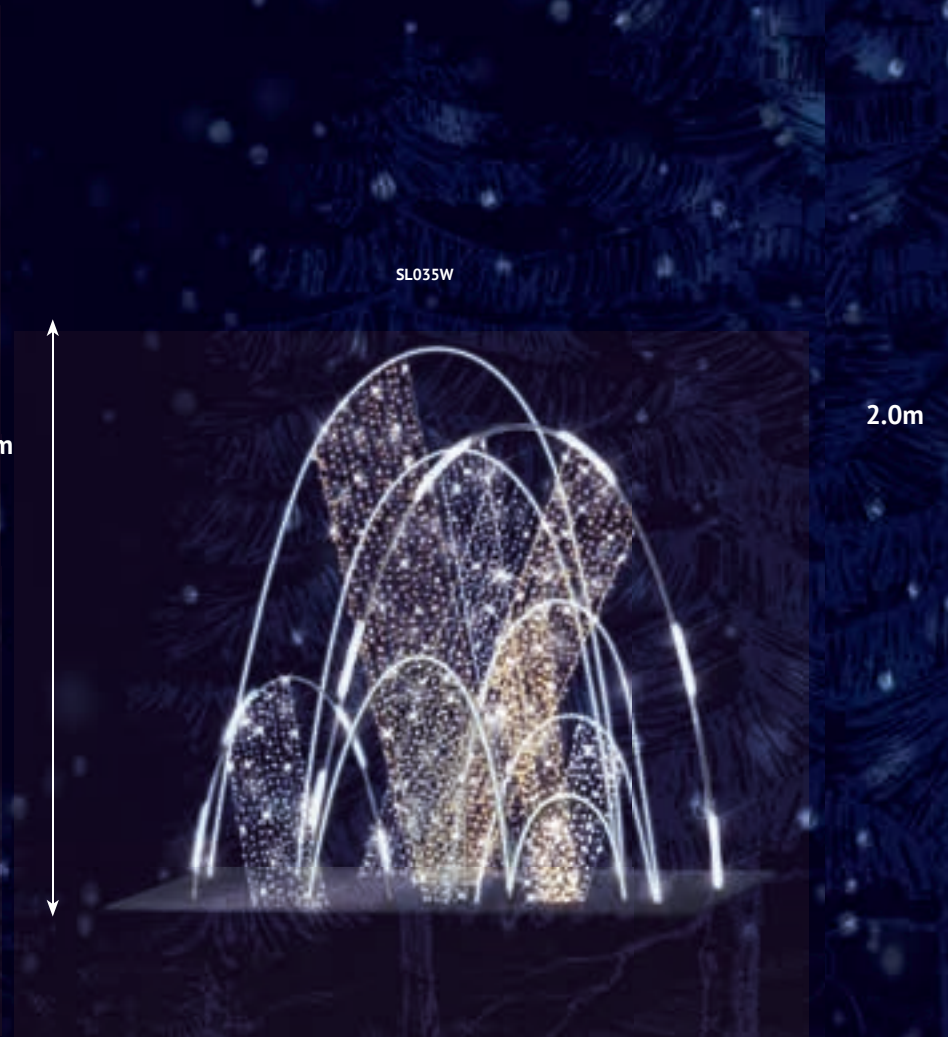

SL035W-TATIANA
 ◆ 2.0m ◆ 2.1m ◆ 0.6m ⚖️ 22.5kg ⚡ 60W
 ● COMETEFLASH



SL040-BLIZZARD FONTAIN
 ◆ 2.0m ◆ 4.0m ◆ 4.0m ⚖️ 55kg ⚡ 140W
 ● COMETEFLASH 122

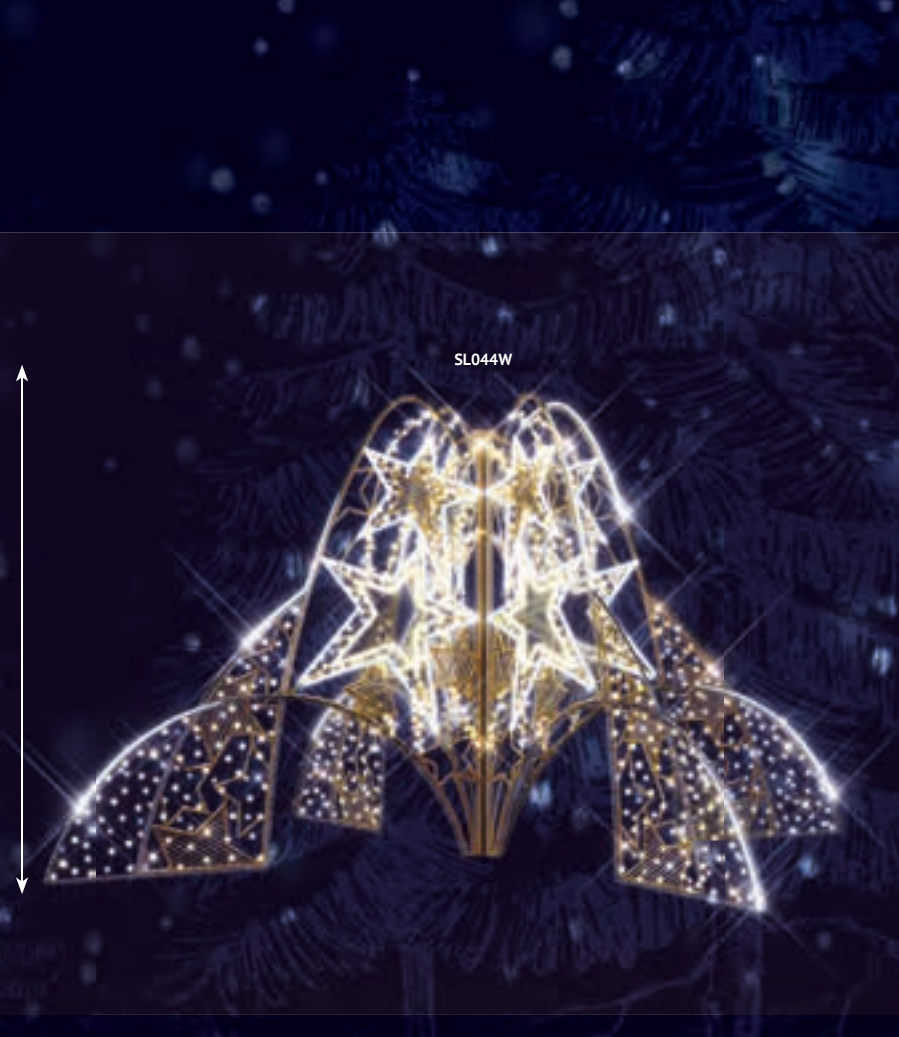

SL044W-ASTRAL FONTAIN
 ◆ 2.0m ◆ 4.0m ◆ 4.0m ⚖️ 82kg ⚡ 120W
 ● FLASH&COMETE 122



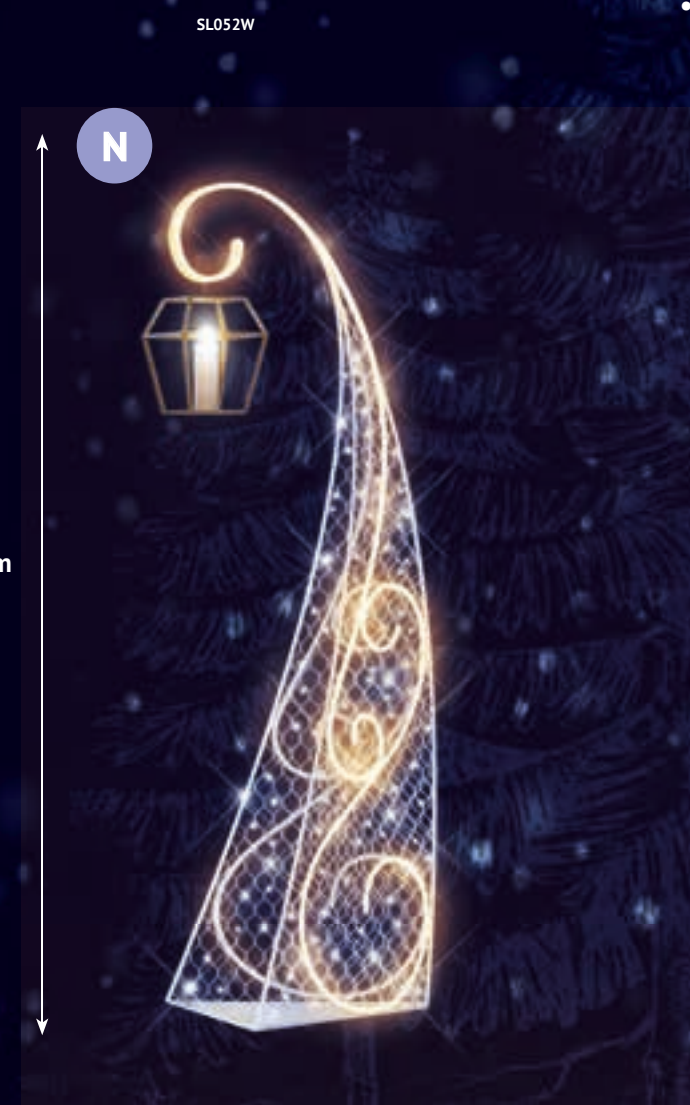
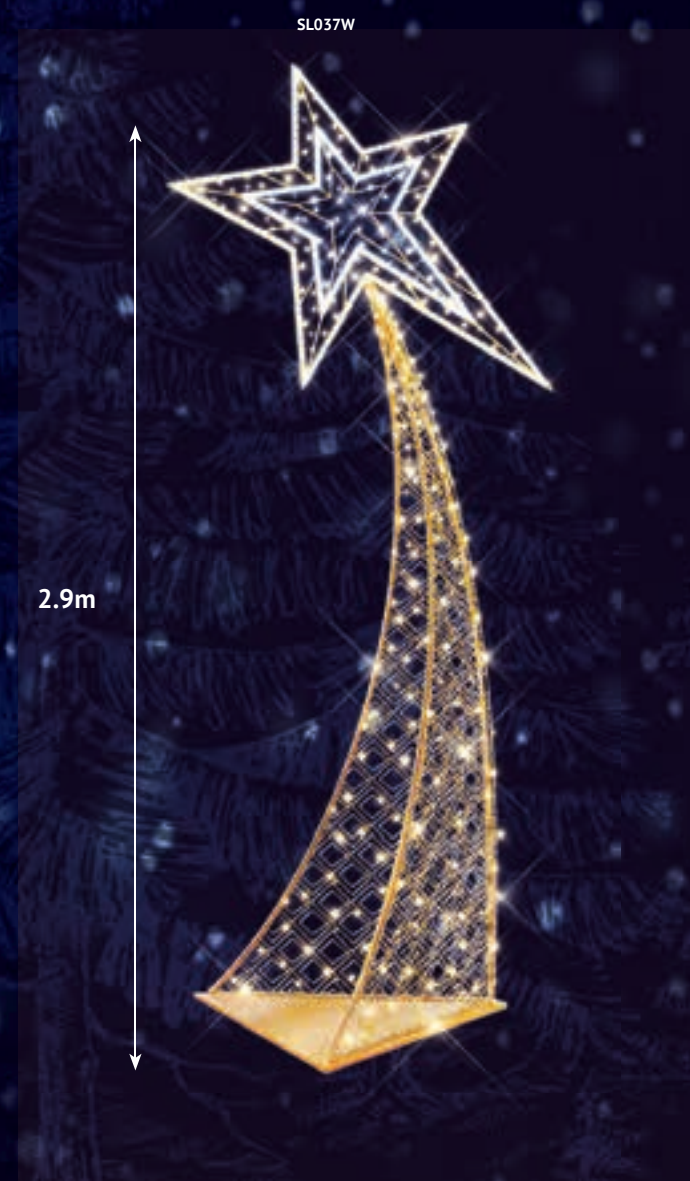
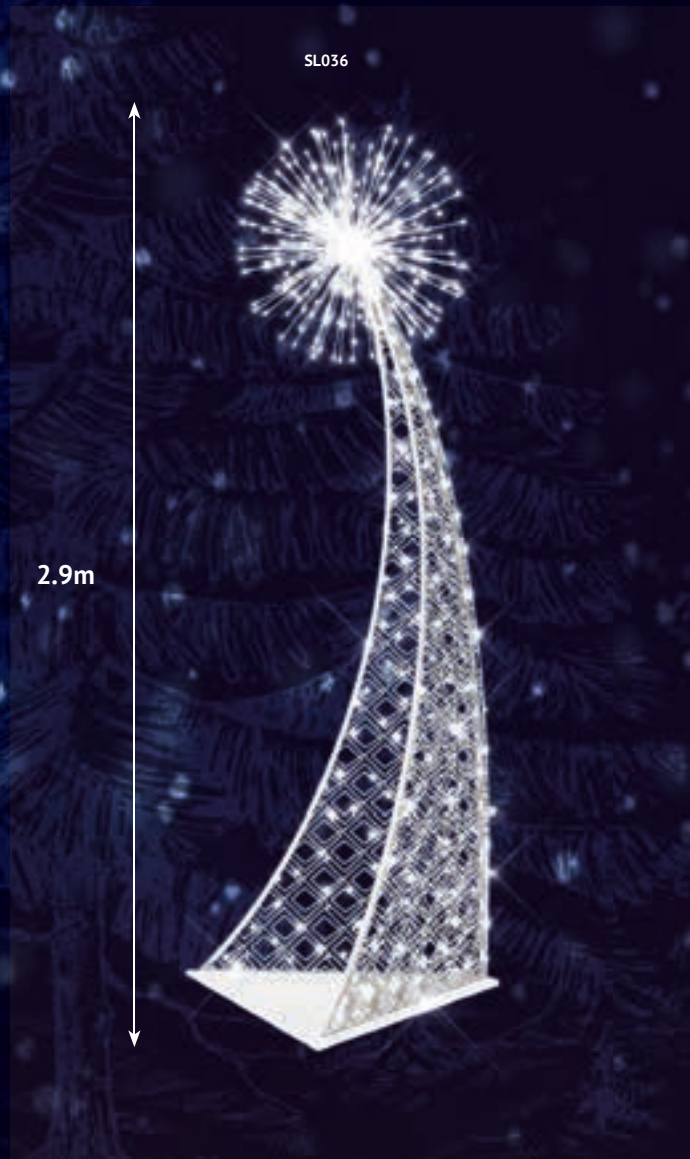

SL036-DEMI ARCHE FEU D'ARTIFICE
 ◆ 2.9m ◀ 1.0m ▣ 0.9m ⚖ 32kg ⚡ 21W
 ● FLASH 70

SL036W-DEMI ARCHE FEU D'ARTIFICE
 ◆ 2.9m ◀ 1.0m ▣ 0.9m ⚖ 32kg ⚡ 21W
 ● FLASH 70

SL037W-DEMI ARCHE COMETE
 ◆ 2.9m ◀ 1.1m ▣ 1.0m ⚖ 24kg ⚡ 20W
 ● FLASH 106

SL052W-DEMI ARCHE CRISTAL
 ◆ 2.5m ◀ 1.0m ▣ 1.0m ⚖ 23kg ⚡ 52W
 ● FLASH 24

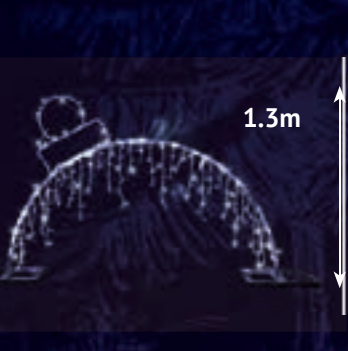
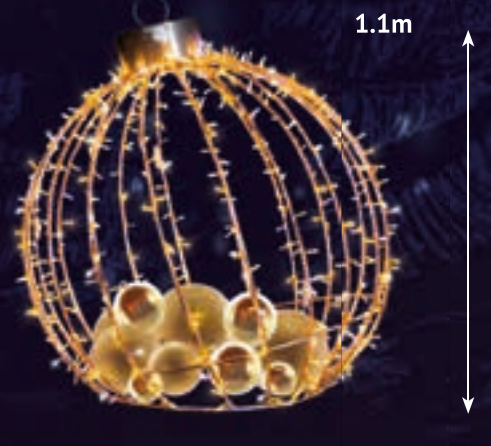
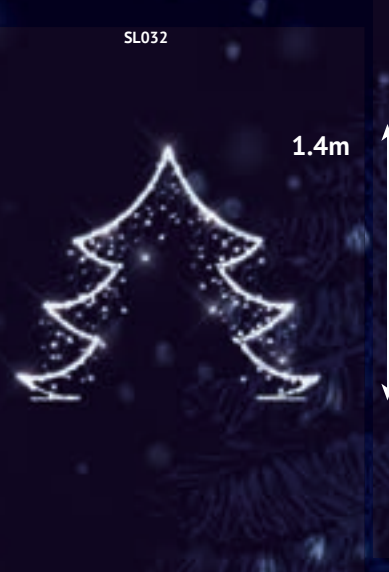
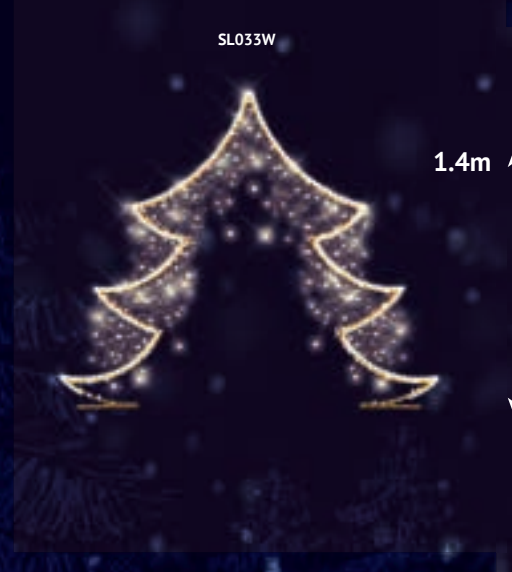
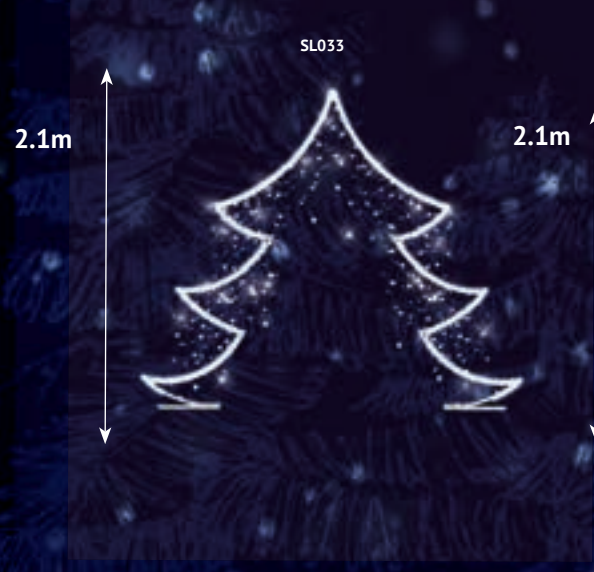
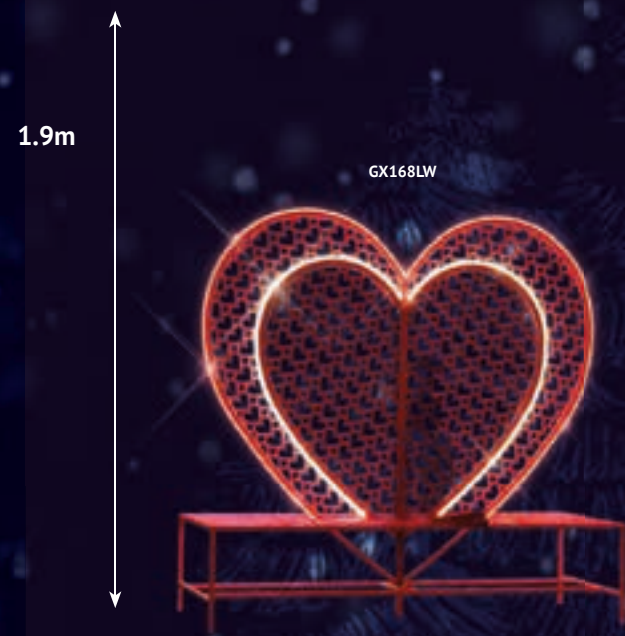
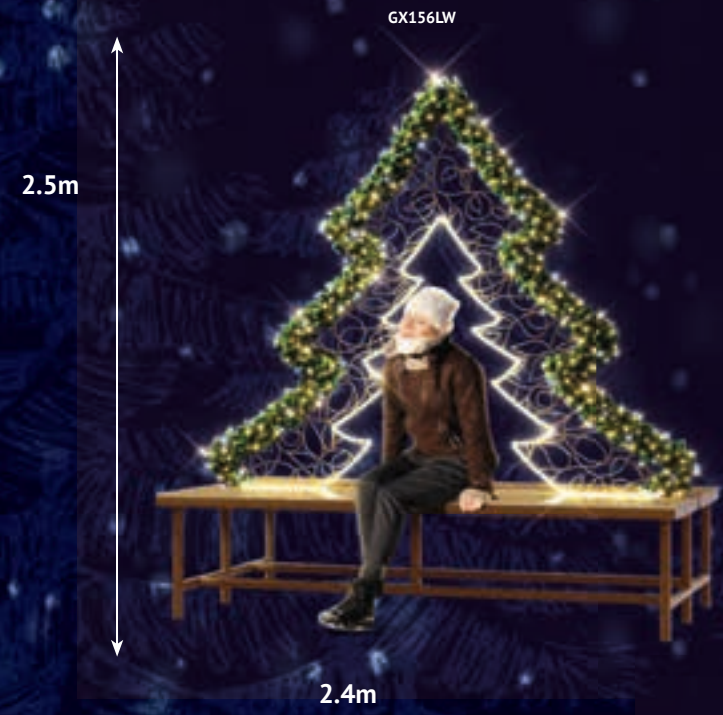

GX156LW-SELFIE TREE
 ◆2.5m ◆2.2m ◆0.9m ▲53.5kg ⚡15W
 FLASH 83

GX168LW-SELFIE LOVE
 ◆1.9m ◆2.0m ◆0.9m ▲36.5kg ⚡20W
 FLASH 139

TO ORDER

GX210LW-STARLIGHT
 ◆0.9m ◆2.4m ◆0.9m ▲34kg ⚡30W
 FLASH

GX327LW-BOULE XMAS
 ◆1.1m ◆1.0m ◆1.0m ▲6.6kg ⚡25W
 FLASH

GX327L-BOULE XMAS
 ◆1.1m ◆1.0m ◆1.0m ▲6.6kg ⚡25W
 FLASH

SL033-SYLVESTRE GM
 ◆2.1m ◆2.5m ▲8.8kg ⚡45W
 FLASH

SL033W-SYLVESTRE GM
 ◆2.1m ◆2.5m ▲8.8kg ⚡45W
 FLASH

SL032-SYLVESTRE PM
 ◆1.4m ◆1.7m ▲7.5kg ⚡40W
 FLASH

SL032W-SYLVESTRE PM
 ◆1.4m ◆1.7m ▲7.5kg ⚡40W
 FLASH

SL013-PROXIMA GM
 ◆2.0m ◆3.5m ▲6kg ⚡45W
 FLASH

SL013W-PROXIMA GM
 ◆2.0m ◆3.5m ▲6kg ⚡45W
 FLASH

SL012-PROXIMA PM
 ◆1.3m ◆2.5m ▲6.4kg ⚡25W
 FLASH

SL012W-PROXIMA PM
 ◆1.3m ◆2.5m ▲6.4kg ⚡25W
 FLASH



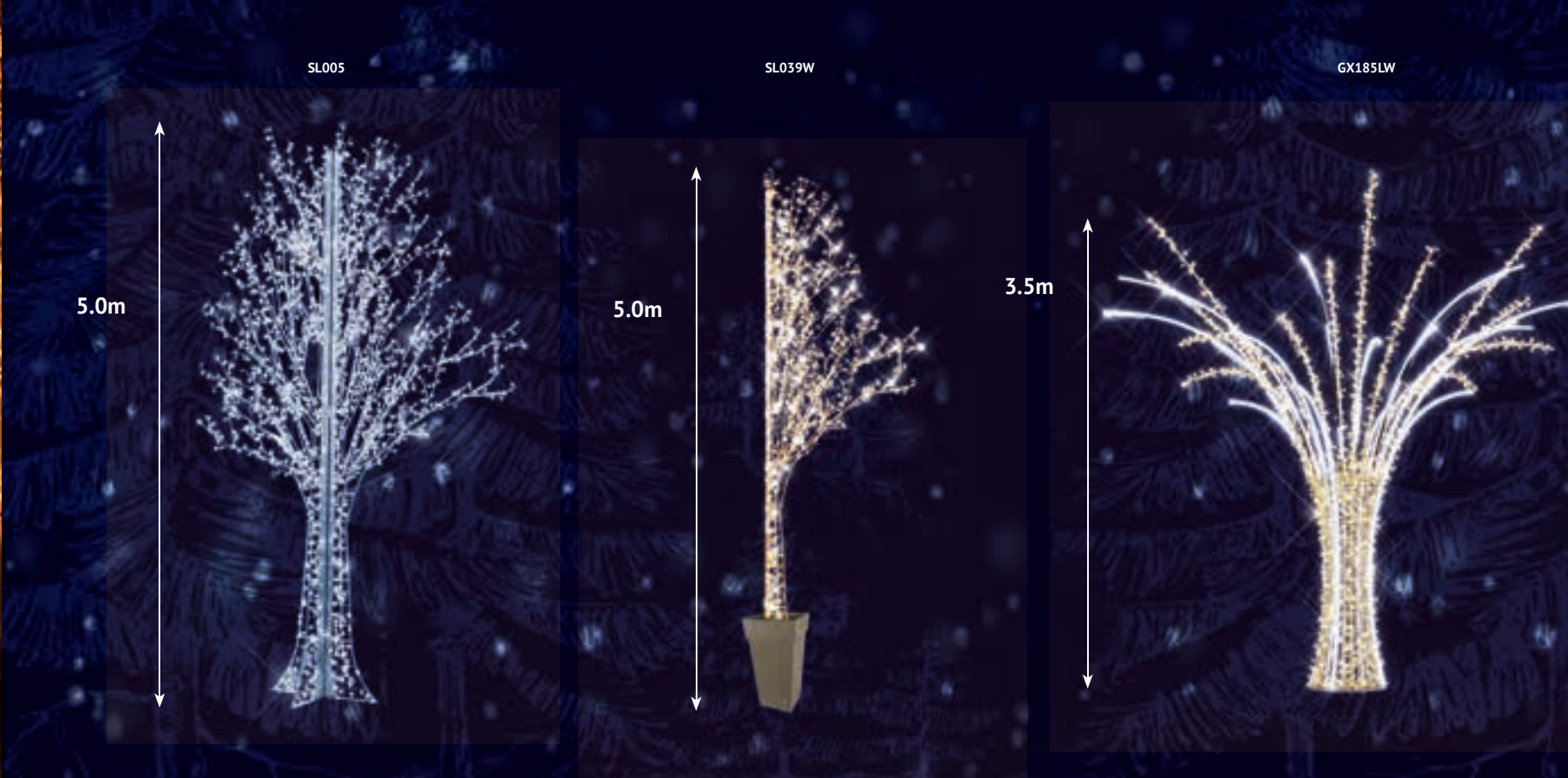
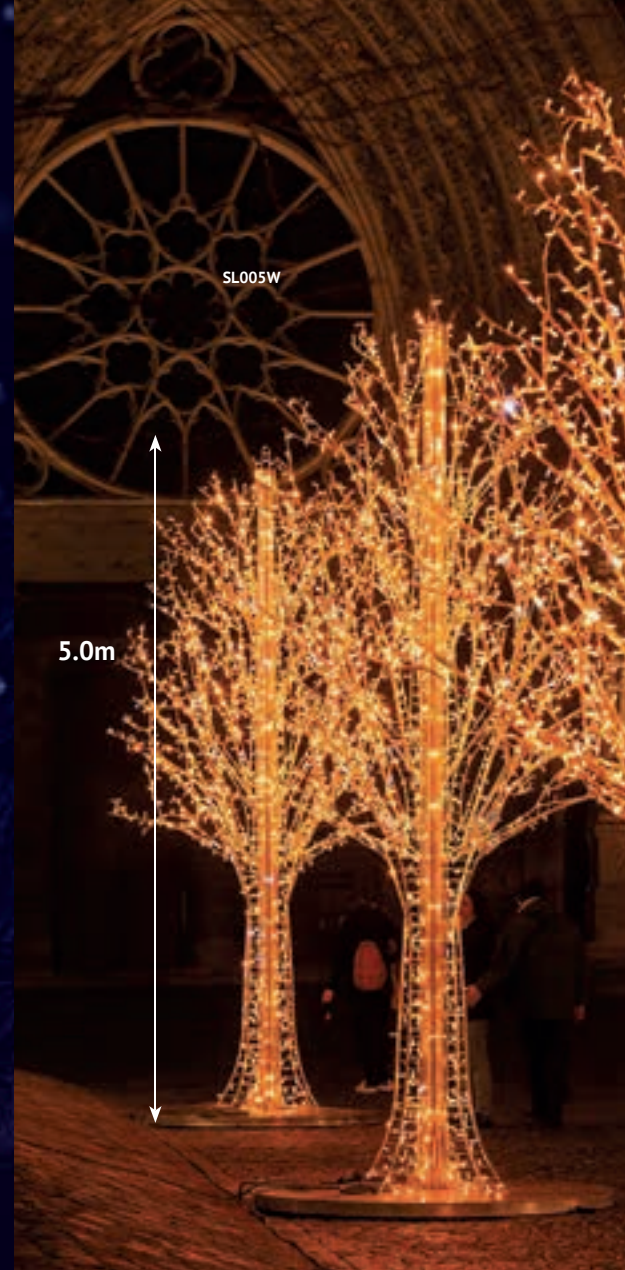
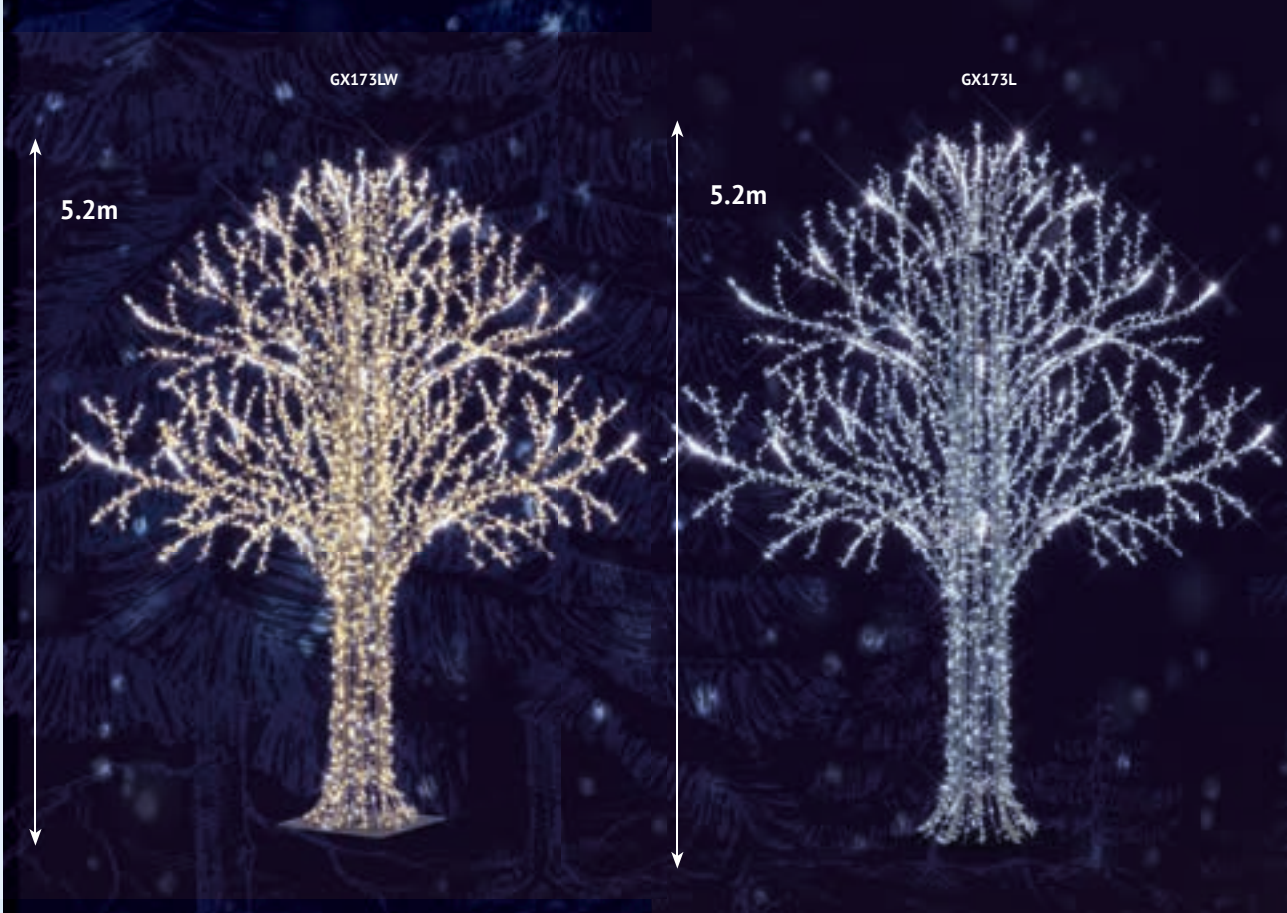

GX173LW- MAGIC
 ◆ 5.2m ◀ 5.0m ▽ 5.0m ⚖ 175kg ⚡ 290W
 ● XLED & FLASH
 TO ORDER

GX173L- MAGIC
 ◆ 5.2m ◀ 5.0m ▽ 5.0m ⚖ 175kg ⚡ 290W
 ● XLED & FLASH

SL005W- BJORK TREE BLANC CHAUD
 ◆ 5.0m ◀ 3.3m ▽ 3.3m ⚖ 205kg ⚡ 100W
 ● FLASH

SL005- BJORK TREE
 ◆ 5.0m ◀ 3.3m ▽ 3.3m ⚖ 205kg ⚡ 100W
 ● FLASH

SL039W- BJORK PM
 ◆ 5.0m ◀ 1.7m ▽ 0.4m ⚖ 40kg ⚡ 20W
 ● FLASH

GX185LW- LINA
 ◆ 3.5m ◀ 3.9m ▽ 3.9m ⚖ 60kg ⚡ 140W
 ● XLED

2 in 1 products!
 You can choose from a warm white or pure white.
 By reversing the connectors, you can obtain either a pure white decor/ pure white flash or a warm white decor/warm white flash.



GX354L- LUX
 ◆ 3.7m ◆ 3.6m ◆ 3.6m ▲ 155kg ⚡ 210W
 ● SOFT XLED

GX354LW- LUX
 ◆ 3.7m ◆ 3.6m ◆ 3.6m ▲ 155kg ⚡ 210W
 ● SOFT XLED

GX266DC- MINI MAGIC
 ◆ 2.5m ◆ 1.6m ◆ 1.6m ▲ 28.5kg ⚡ 90W
 ● FLASH

GX355LW- GRACE TREE
 ◆ 2.4m ◆ 2.0m ◆ 2.0m ▲ 38kg ⚡ 74W
 ● SOFT XLED 19

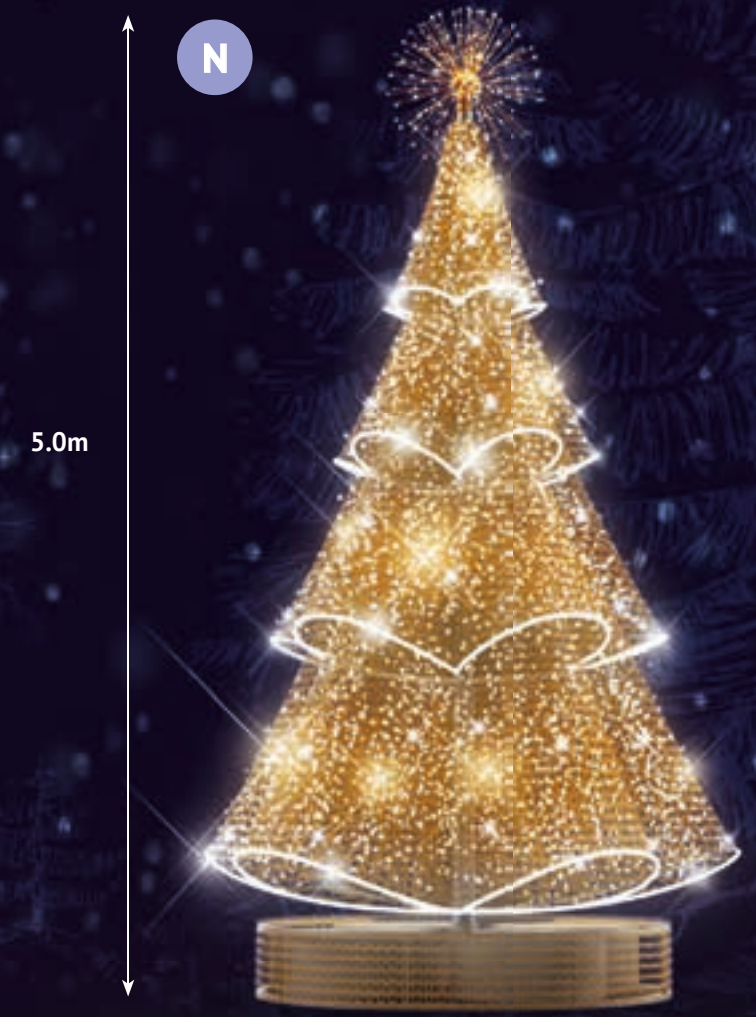
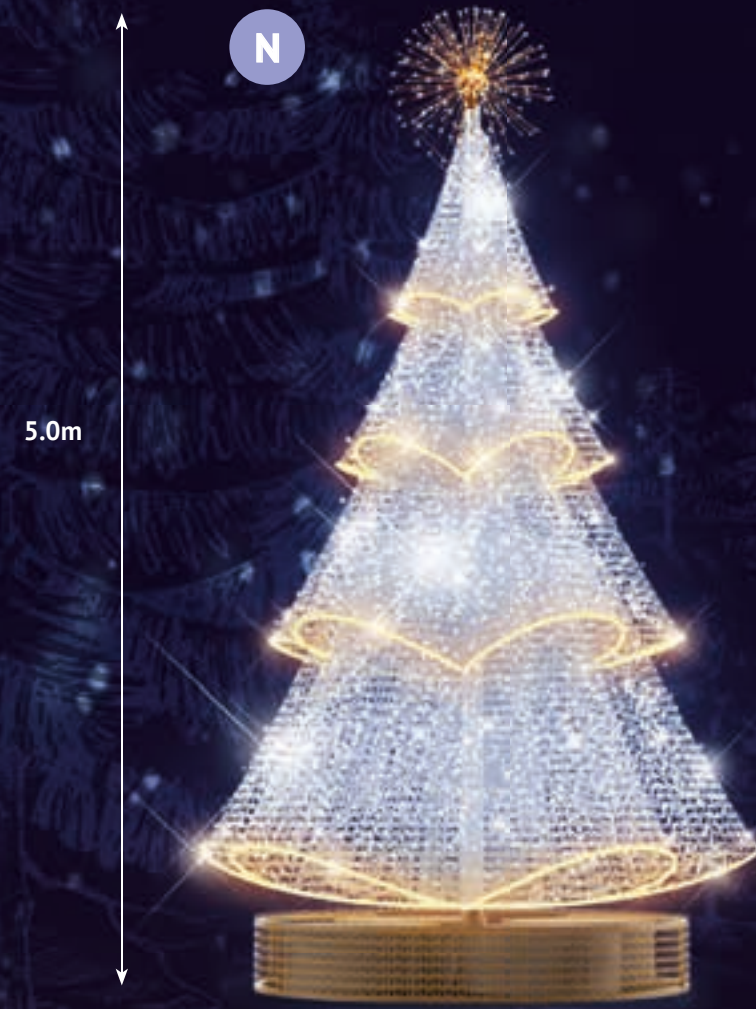
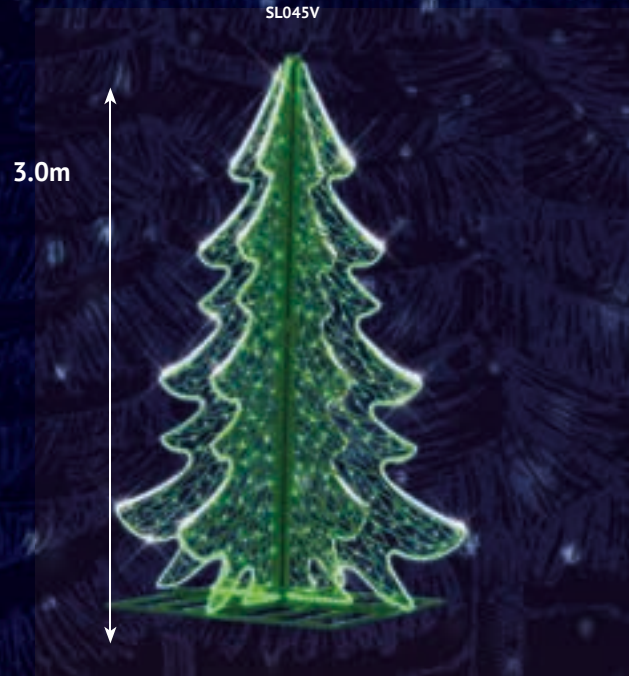
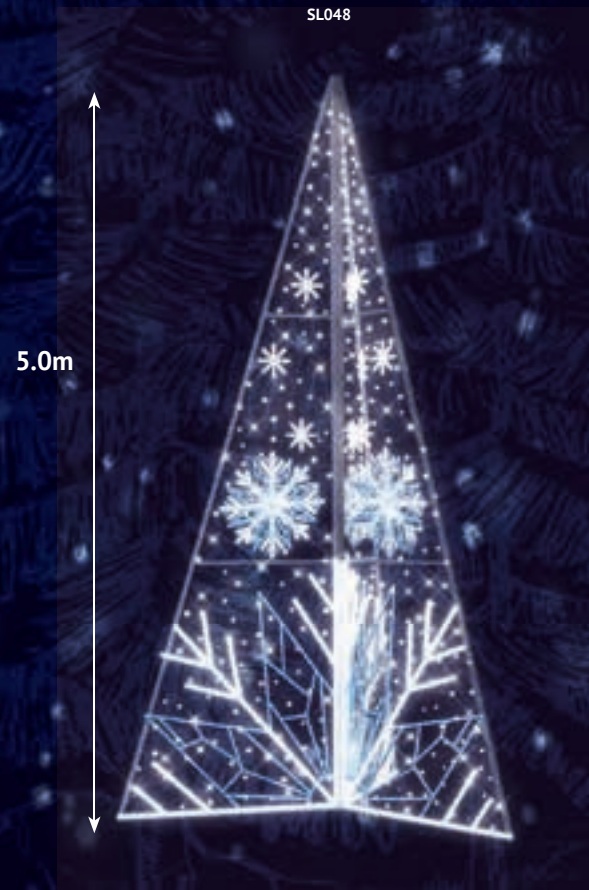

SL048- EMY

5.0m 3.0m 1.5m 74.5kg 150W

FLASH&STARS 523

TO ORDER

SL049W- JUDY

5.0m 3.0m 1.5m 70kg 75W

FLASH&STARS 523

TO ORDER

SL045V- VERDE

3.0m 2.3m 2.3m 45.5kg 180W

XLED 299

GX344L- SCALA

5.0m 3.0m 3.0m 155kg 150W

FLASH

GX344LW- SCALA

5.0m 3.0m 3.0m 155kg 150W

FLASH





SLED010W-MARINA
 ◆ 7.5m ◆ 3.4m ◆ 3.4m 🏠 152kg ⚡ 265W
 ● FLASH
 TO ORDER

SND017-GRAND VEGA FROZEN
 ◆ 6.3m ◆ 2.2m ◆ 2.2m 🏠 170kg ⚡ 275W
 ● STARSFLASH 🏠 286

SV502W-CELESTE
 ◆ 6.0m ◆ 1.9m ◆ 1.9m 🏠 97kg ⚡ 185W
 ● FLASH 🏠 598
 TO ORDER



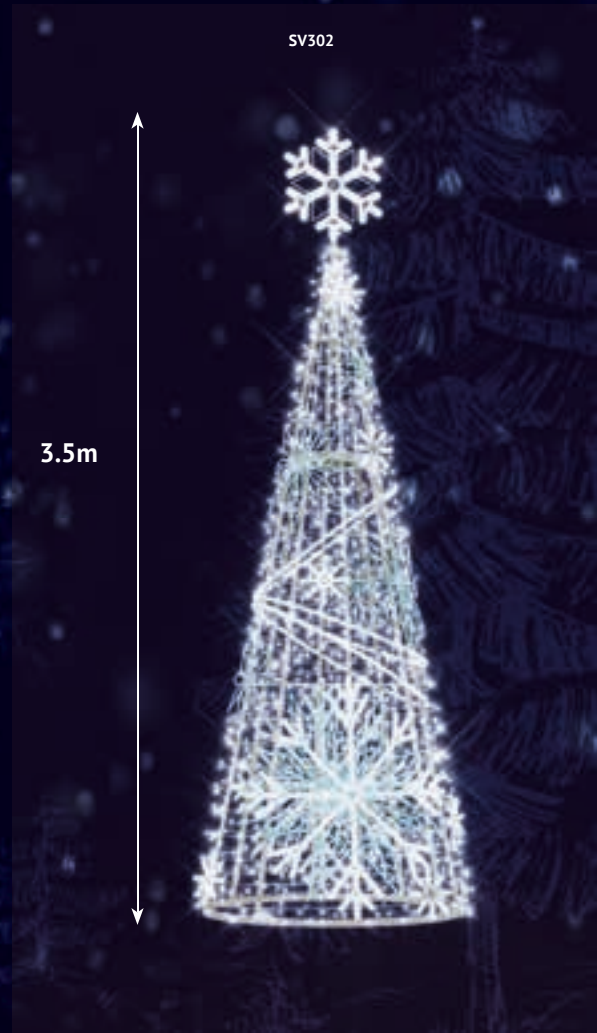
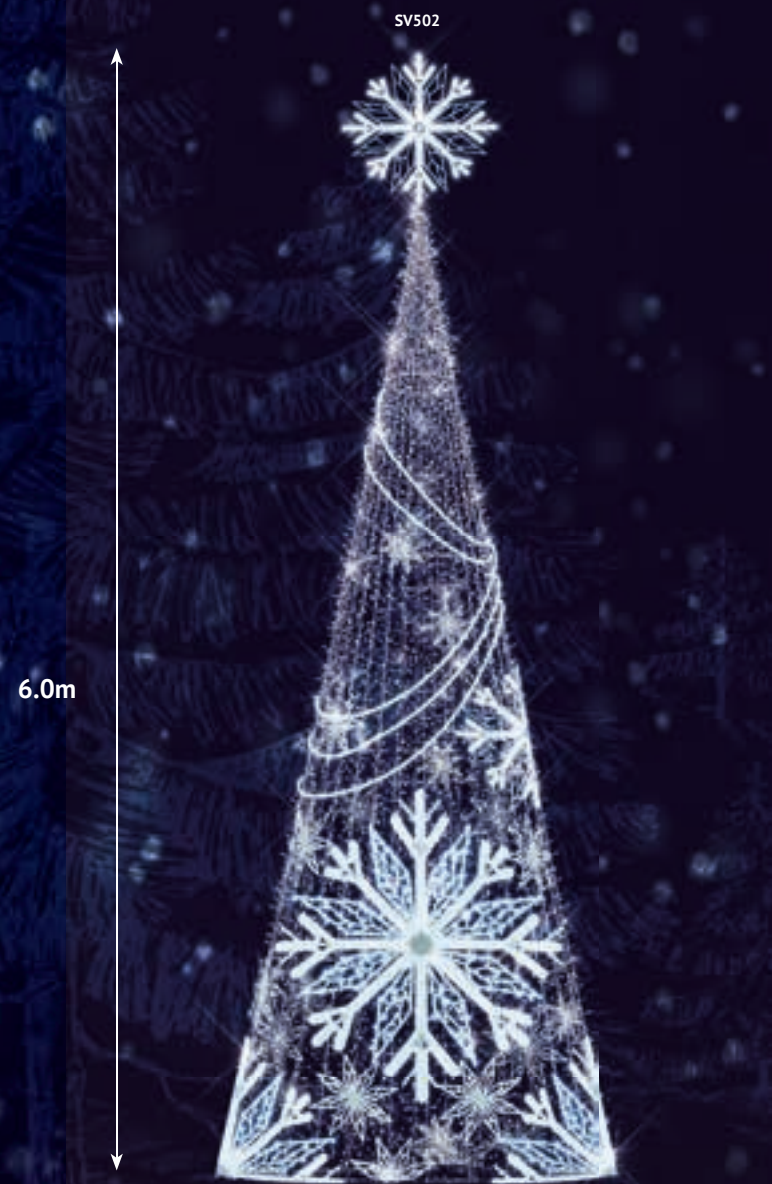
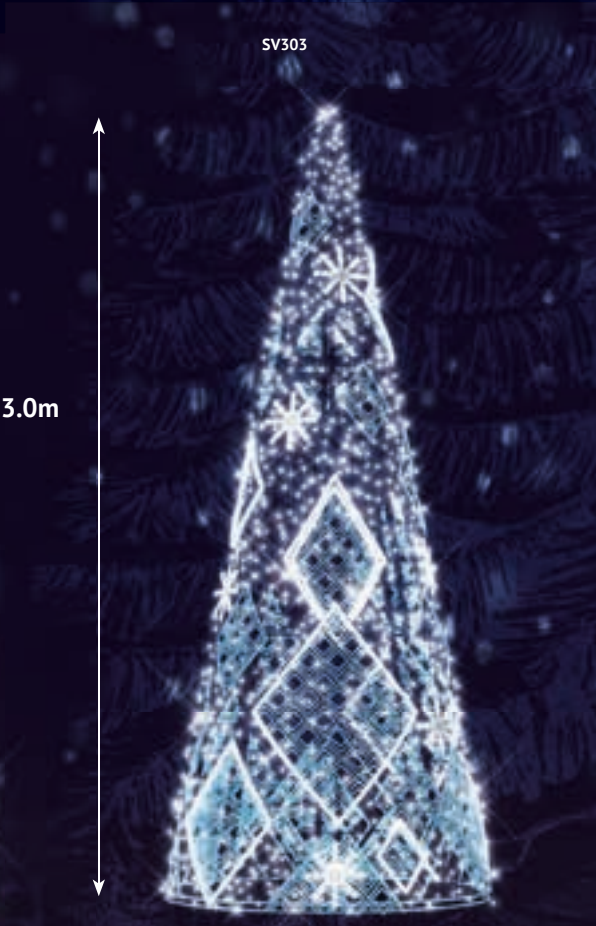
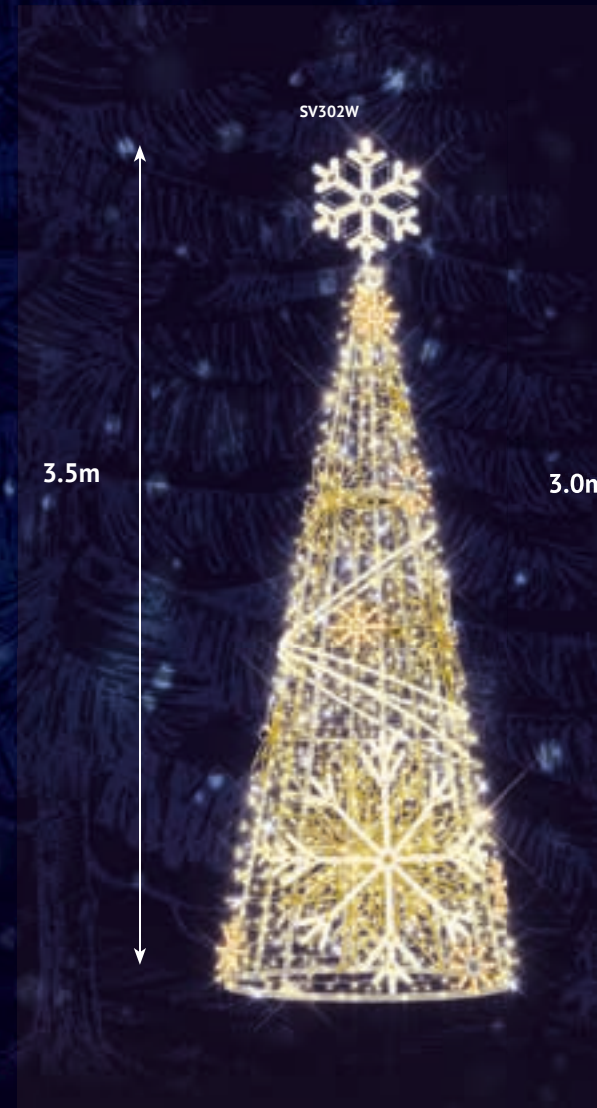

SV302W- PETIT CELESTE

3.5m 1.2m 1.2m 34kg 70W
 FLASH&STARS 419

SV303W- QUADRI TREE

3.0m 1.2m 1.2m 30kg 55W
 FLASH&STARS 199

SV303- QUADRI TREE

3.0m 1.2m 1.2m 30kg 55W
 FLASH&STARS 199

SV502- CELESTE

6.0m 1.9m 1.9m 97kg 185W
 FLASH 598
 TO ORDER

SV302- PETIT CELESTE

3.5m 1.2m 1.2m 34kg 70W
 FLASH&STARS 419





GX253LW-TOM
 ◆ 5.0m ◆ 2.3m ◆ 2.3m 🏠 282kg ⚡ 120W
 🟡 🟢 FLASH 📶 273
 TO ORDER

GX251L- BUBBLE
 ◆ 5.0m ◆ 2.5m ◆ 2.5m 🏠 245kg ⚡ 135W
 🔵 🟡 FLASH
 TO ORDER

GX251LW- BUBBLE
 ◆ 5.0m ◆ 2.5m ◆ 2.5m 🏠 245kg ⚡ 135W
 🟡 🟢 FLASH
 TO ORDER



Description	Height	ø	P(W)	Nb of light points	Weight	Parts number	○	●
Conical fir tree 3m	3,00 m	1,18 m	24 W	612 + 156 flashes	49 kg	3	SV301	SV301W
Conical fir tree 5m	5,00 m	1,80 m	64 W	1028 + 364 flashes	241 kg	7	SV501	SV501W
Conical fir tree 10m	10,00 m	3,43 m	252 W	6528 + 1664 flashes	985 kg	23	SV1001	SV1001W
Conical "crossing" fir tree 2m	8,00 m	2,78 m	200 W	4284 + 1092 flashes	585 kg	17	SV801-P	SV801W-P
Conical "crossing" fir tree 12m	12,00 m	4,08 m	420 W	10149 + 2587 flashes	1174 kg	39	SV1201-P	SV1201W-P

TO ORDER

SND022-ROMANTIC
 ◆8.0m ◆2.7m ◆2.7m ⚖315kg ⚡300W
 ● STARS&&COMETEFASH
TO ORDER

SND019-GRAND VEGA GREEN
 ◆6.3m ◆2.2m ◆2.2m ⚖170kg ⚡275W
 ● STARS&XLED ⚡286

SV507W-ALPS TREE
 ◆5.4m ◆1.9m ◆1.9m ⚖129kg ⚡197W
 ● STARS&XLED ⚡356

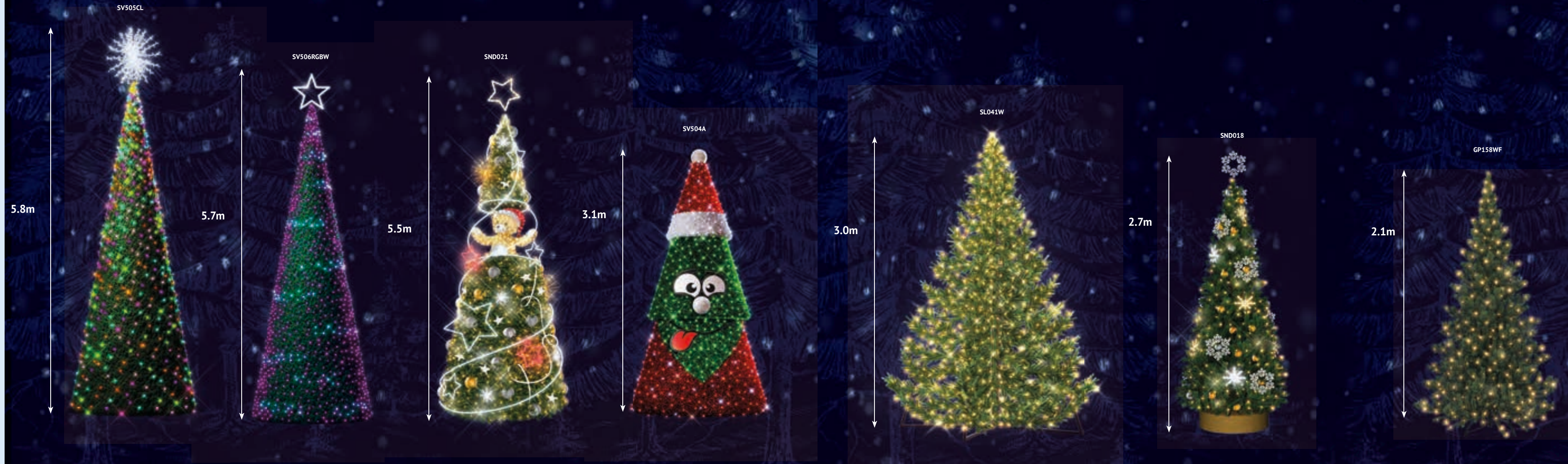

SV505CL- CHERRY TREE
 ◆ 5.8m ◆ 1.9m ◆ 1.9m 🏠 116kg ⚡ 90W
 🌈 RGBWW&FLASH
 TO ORDER

SV506RGBW-FULL-COLOUR TREE
 ◆ 5.7m ◆ 1.9m ◆ 1.9m 🏠 150kg ⚡ 200W
 🌈 RGBWW
 TO ORDER

SND021- TEDDY
 ◆ 5.5m ◆ 2.5m ◆ 2.5m 🏠 172kg ⚡ 325W
 🌈 FLASH
 TO ORDER

SV504A- DAVE A
 ◆ 3.1m ◆ 1.6m ◆ 1.6m 🏠 44.5kg ⚡ 35W
 🌈 FLASH
 TO ORDER

SL041W-NORDIKA 3D - ECO
 ◆ 3.0m ◆ 2.4m ◆ 2.4m 🏠 72kg ⚡ 125W
 🟡 SLOWGLOW 📦 214



SND018-VEGA GREEN
 ◆ 2.7m ◆ 0.9m ◆ 0.9m 🏠 25.5kg ⚡ 30W
 🌈 FLASH 📦 46
 TO ORDER

GP158WF- SAPIN VERT PRE ILLUMINE - H2,10M
 ◆ 2.1m ◆ 1.4m ◆ 1.4m 🏠 18kg ⚡ 25W
 🟡 (306) FLASH (78)

NORDIKA, AS REALISTIC AS A NATURAL ONE

Who doesn't love a fabulous Christmas tree?

And yet, it takes between 30 and 40 years for a natural conifer to reach 12m in height. As we want to avoid deforestation halting the felling of these majestic trees, we invented NORDIKA.

Pre-illuminated with a slowglow effect, easy to assemble and store, they are perfect replicas of their natural version, both in their design and incredibly realistic appearance - as true to life as

it gets.

Our environmental approach is based on a simple principle: to save at least as much carbon as we generate. We do this by only using biocompatible materials, which we recycle at the end of their lifespan.



**OPTIONAL
TREETOP**



**HYPER REALISTIC
CHRISTMAS TREE BRANCHES**



WOOD-EFFECT TRUNK



**WOOD EFFECT
STAND AVAILABLE**



NORDIKA, THE CHRISTMAS TRADITION

The perfect regularity of the branches, the realistic high-quality finishes and a majestic size make our conifers a festive must. You can customise your Nordika every year for a unique look: hang

Christmas baubles on its branches, add a set of lights, or even set it on a wooden base.

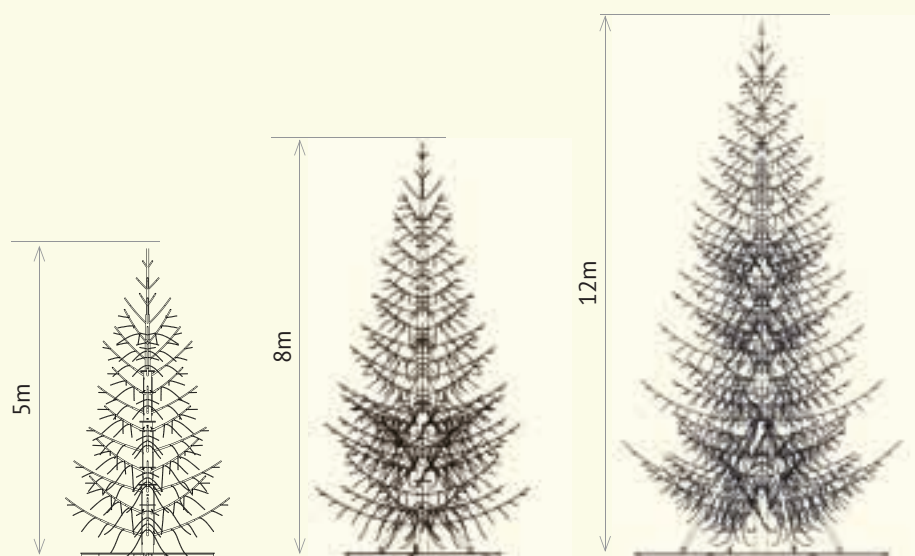

TO ORDER

Ref	Name	Height	ø	P(W)	Weight	No of elements	Colour of Led	No of Led
GX081LW-2	sapin Nordika - PM	5,00 m	3,56 m	245 W	263 kg	46	☀	2976 (1488 steady + 1488 with slowglow effect)
GX082LW	sapin Nordika - MM	8,00 m	4,70 m	770 W	1 112 kg	107	☀	8664 (4332 steady + 4332 with slowglow effect)
GX083LW	sapin Nordika - GM	12,00 m	5,90 m	1870 W	2 750 kg	194	☀	21048 (10524 steady + 10524 with slowglow effect)



**FREE STANDING
NO NEED TO SECURE WITH
WIRES**

The Nordika is built on a robust internal framework that ensures its stability without the need for external cables or wires for balance.

**TOTALLY
SAFE 24V**

100% secure thanks to its 24V voltage across the entire tree.

**INDOOR &
OUTDOOR USE**

Thanks to its weather-resistant structure and durable materials, it withstands outdoor conditions perfectly while remaining elegant and safe indoors.

**PVC
FREE**

The recyclable polyethylene branches provide a natural appearance and an eco-friendly approach. This innovative material perfectly mimics the look of real branches while being durable and environmentally friendly.

**PRE-LIGHTED
WITH 100% LED
SLOWGLOW EFFECT**

No need to install string lights anymore: the tree comes pre-decorated and ready to shine.

**CAN BE TOTALLY
DISMANTLED**

Transport and storage are also made easier.

NORDIKA, ACCESSORIES

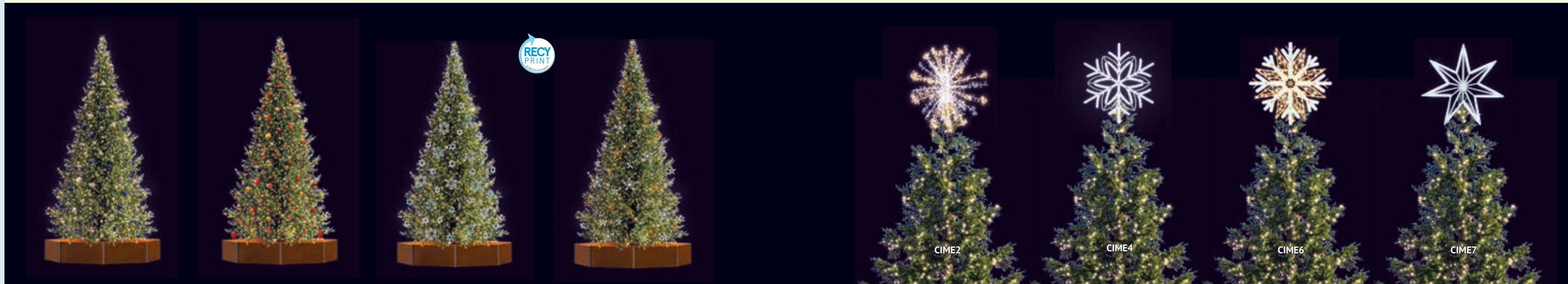

DECORATIVE BAUBLES KIT

Each kit features 52 baubles in the same colour (M1/B1 category-fireproof)-50% shiny /50% satiny
 - 28 baubles ø 12cm
 - 20 baubles ø 20cm
 - 4 baubles ø 25cm

SILVER : KITNDK-A
 BLUE : KITNDK-B
 GOLD : KITNDK-O
 RED : KITNDK-R

NORDIKA - 5 M = 2 kits - 104 baubles
NORDIKA - 8 M = 4 kits - 208 baubles
NORDIKA - 12 M = 8 kits - 416 baubles

BIOPRINT & RECYPRINT KIT

Each kit features 20 motives
 - 8 motives ø 50cm
 - 12 motives ø 30cm

BLUE/WHITE - SNOWFLAKE : KITNDK-F
 GOLD/WHITE - STAR : KITNDK-E

NORDIKA - 5 M = 2 kits - 40 decorations
NORDIKA - 8 M = 4 kits - 80 decorations
NORDIKA - 12 M = 8 kits - 160 decorations

TREE TOPPER

These carefully designed toppers allow you to customize the top of your tree, giving it a unique and magical finish.

CIMIER STAR7 - 0,80M : CIME7
 CIMIER BELLA - 1,00M : CIME2
 CIMIER MIA - 1,00M : CIME6
 CIMIER AIGUILLE - 1,00M : CIME4



BASE

Stabilize and enhance your Nordika tree with our specially designed bases!

NORDIKA 5M (GX081LW-2) : SOCLGX81
 NORDIKA 8M (GX082LW) : SOCLGX82
 NORDIKA 12M (GX083LW) : SOCLGX83





SUSPENSIONS COLLECTIONS

GENERAL CATALOGUE

ARTY

The ARTY collection is inspired by the refinement and purity of the Art Deco artistic movement. We have elegantly mixed the geometric lines of this timeless artistic style with the traditional symbols of Christmas.

Flashes, diamond shapes and streamlined curves are accented with light, enabling us to create an extremely elegant and dynamic decoration that is equally beautiful day and night in your streets.

- ART DECO
- REFINEMENT
- GEOMETRIC SHAPES
- ELEGANCE
- FLASH OF LIGHT
- DROP BEADS

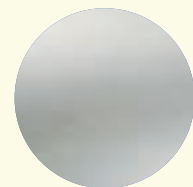
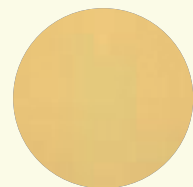
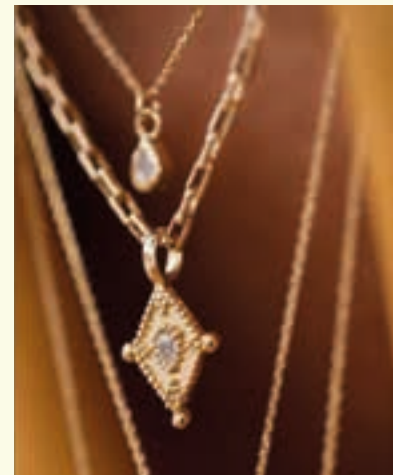

IPL337W **N** IPL336W **N** IPL335W **N**

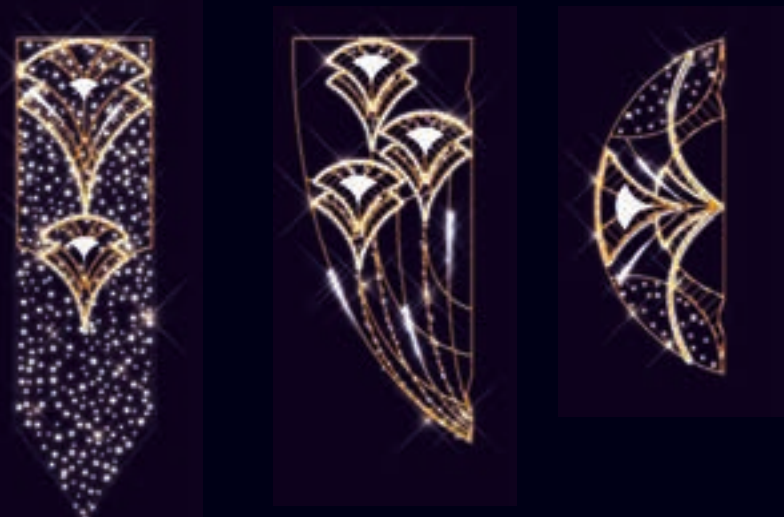

IPL337 **N** IPL336 **N** IPL335 **N**

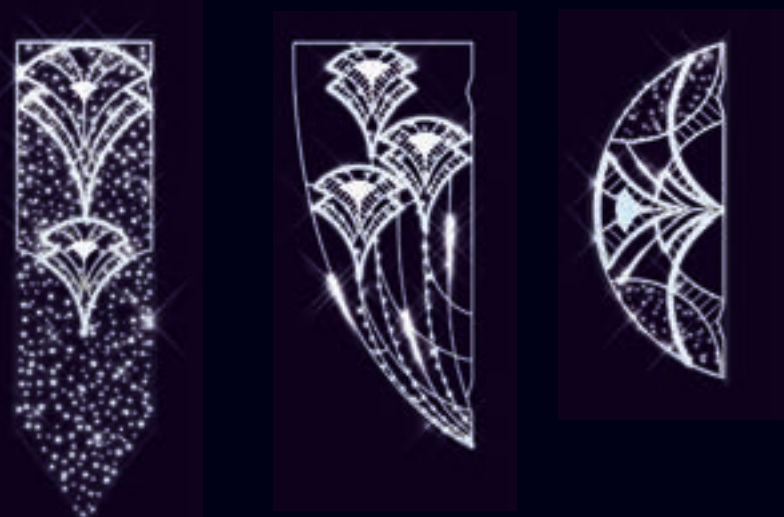

ITL338W **N**

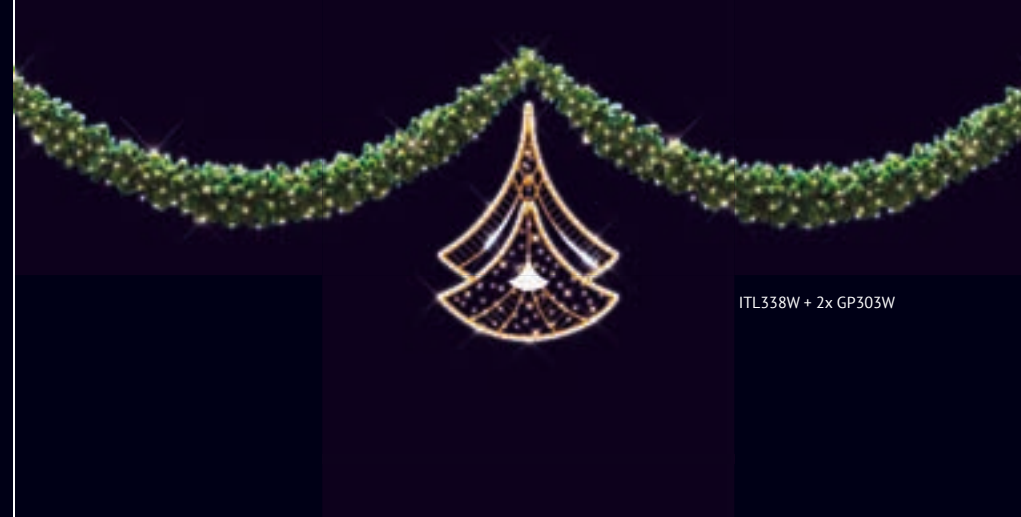

ITL338W + 2x GP303W

ITL338 **N**



ITL338W + 2x GP303W



ITL338W / IPL336W



IPL337W- GATSBY BANNER
 2.8m x 0.8m | 8kg | 50W
 SLOWFLASH & SOFT XLED | 52

IPL337- GATSBY BANNER
 2.8m x 0.8m | 8kg | 50W
 SLOWFLASH & SOFT XLED | 52

IPL336W- GATSBY GRAND
 2.0m x 0.9m | 8kg | 49W
 SLOWFLASH & SOFT XLED | 79

IPL336- GATSBY GRAND
 2.0m x 0.9m | 8kg | 49W
 SLOWFLASH & SOFT XLED | 79

IPL335W- GATSBY
 1.5m x 0.6m | 5kg | 34W
 SLOWFLASH & SOFT XLED | 37

IPL335- GATSBY
 1.5m x 0.6m | 5kg | 34W
 SLOWFLASH & SOFT XLED | 37

ITL338W- GATSBY UNIT
 1.0m x 0.8m | 4kg | 30W
 SLOWFLASH & SOFT XLED | 29

ITL338- GATSBY UNIT
 1.0m x 0.8m | 4kg | 30W
 SLOWFLASH & SOFT XLED | 29

IPL144W



IPL129W



IPL130W



IPL131W



IPL143W



IPL230W



ITL161W



ITL129W

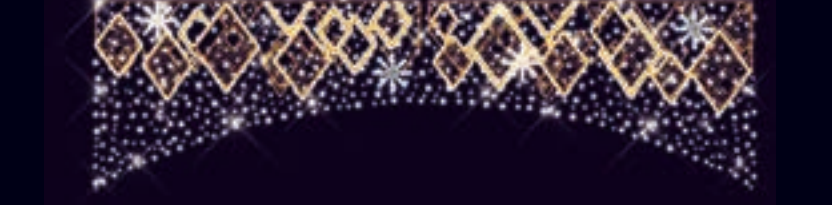

ITL130W



ITL291W



ITL291W + 1 TSL2W



ITL161W



ITL130W



IPL130W

IPL144W-QUADRILLE GRAND

3.0m x 1.0m | 10.5kg | 50W
 STARS & SLOWFLASH & XLED | 93

IPL129W-QUADRILLE

2.0m x 0.9m | 7.6kg | 40W
 STARS & SLOWFLASH | 57

IPL130W-QUADRILLE PETIT

1.2m x 0.6m | 4kg | 20W
 STARS & SLOWFLASH | 33

ITL161W-QUADRILLE CHAIN

1.2m x 5.0m | 25.5kg | 90W
 XLED & STARS & FLASH | 116

ITL130W-QUADRILLE CURVE

1.0m x 1.0m | 15.1kg | 80W
 STARS & SLOWFLASH | 114

IPL131W-QUADRILLE BANNER

2.8m x 0.8m | 9.7kg | 50W
 STARS & SLOWFLASH | 8

IPL143W-SERENADE

1.5m x 0.6m | 3.9kg | 25W
 STARS & SLOWFLASH & FLASH | 34

IPL230W-QUADRILLE ROLL

1.3m x 1.0m | 5kg | 25W
 XLED & STARS & FLASH | 45

ITL129W-QUADRILLE ARC

1.2m x 1.0m | 18kg | 100W
 STARS & SLOWFLASH | 132

ITL291W-QUADRILLE UNIT

0.8m x 0.7m | 2.4kg | 15W
 SLOWFLASH & STARS & XLED | 26



IPL144



IPL129



IPL130



IPL131



IPL143



IPL230



ITL161

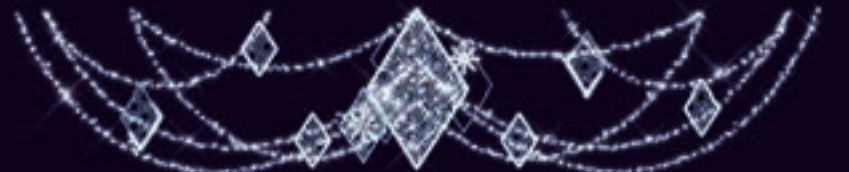

ITL129



ITL130

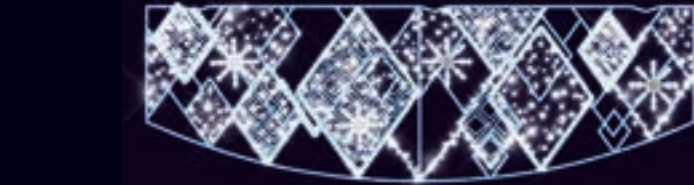

ITL291



ITL291 + 1 TSL2

IPL144-QUADRILLE GRAND

2.0m x 1.0m | 10.5kg | 50W
 STARS&SLOWFLASH&XLED | 93

IPL129-QUADRILLE

2.0m x 0.9m | 7.6kg | 40W
 STARS&SLOWFLASH | 57

IPL130-QUADRILLE PETIT

1.2m x 0.6m | 4kg | 20W
 STARS&SLOWFLASH | 33

ITL161-QUADRILLE CHAIN

1.2m x 6.0m | 25.5kg | 90W
 XLED&STARS&FLASH | 116

ITL130-QUADRILLE CURVE

1.0m x 3.0m | 15.1kg | 80W
 STARS&SLOWFLASH | 114

TO ORDER

IPL131-QUADRILLE BANNER

2.8m x 0.8m | 9.7kg | 50W
 STARS&SLOWFLASH | 8

IPL143-SERENADE

1.5m x 0.6m | 3.9kg | 25W
 STARS&SLOWFLASH | 34

IPL230-QUADRILLE ROLL

1.3m x 1.0m | 5kg | 25W
 XLED&STARS&FLASH | 45

ITL129-QUADRILLE ARC

1.2m x 1.0m | 18kg | 100W
 STARS&SLOWFLASH | 132

ITL291-QUADRILLE UNIT

0.8m x 0.7m | 2.4kg | 15W
 SLOWFLASH&STARS&XLED | 26



ITL161 / IPL131

ITL101W



ITL102W



ITL022W



ITL101



ITL102



ITL022



ITL316W



ITL315



ITL315 + 1 TSL2W

ITL163



ITL233



ITL101W-GRAND MIA

2.0m x 2.0m 18kg 150W
SLOWFLASH 216

ITL102W-MIA

1.0m x 1.0m 5.8kg 45W
SLOWFLASH 73

ITL022W-DENDRA

1.0m x 0.9m 3kg 30W
41

ITL316W-HEXA CHAIN

1.0m x 4.0m 15kg 95W
FLASH & SOFT XLED

ITL163-THORN CHAIN

1.2m x 6.0m 26.5kg 115W
XLED&SLOWFLASH&STARS 194

ITL101-GRAND MIA

2.0m x 2.0m 18kg 150W
SLOWFLASH 216

ITL102-MIA

1.0m x 1.0m 5.8kg 45W
SLOWFLASH 73

ITL022-DENDRA

1.0m x 0.9m 3kg 30W
41

ITL315-HEXA

1.0m x 0.9m 4kg 27W
41

ITL233-QUADRILLE JF

0.8m x 4.5m 15.1kg 105W
XLED&FLASH&STARS 166



Grace

The GRACE collection is inspired by Baroque style. Born in Italy in the 17th century, this artistic movement is characterised by its majestic ornamentation and arabesques, symbols that we have chosen to combine with more pared-back contemporary lines. An essential element in Baroque style, the chandelier is available in several versions that you will find in these pages.

BAROQUE
ARABESQUES
CHANDELIERS
ELEGANCE
ORNAMENTATION
GILDING

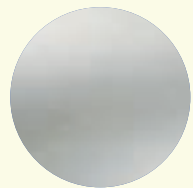
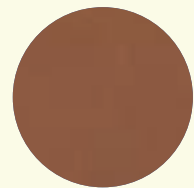
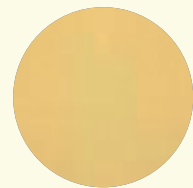

IPL317R **N** IPL318R **N** IPL320R **N** IPL319R **N**

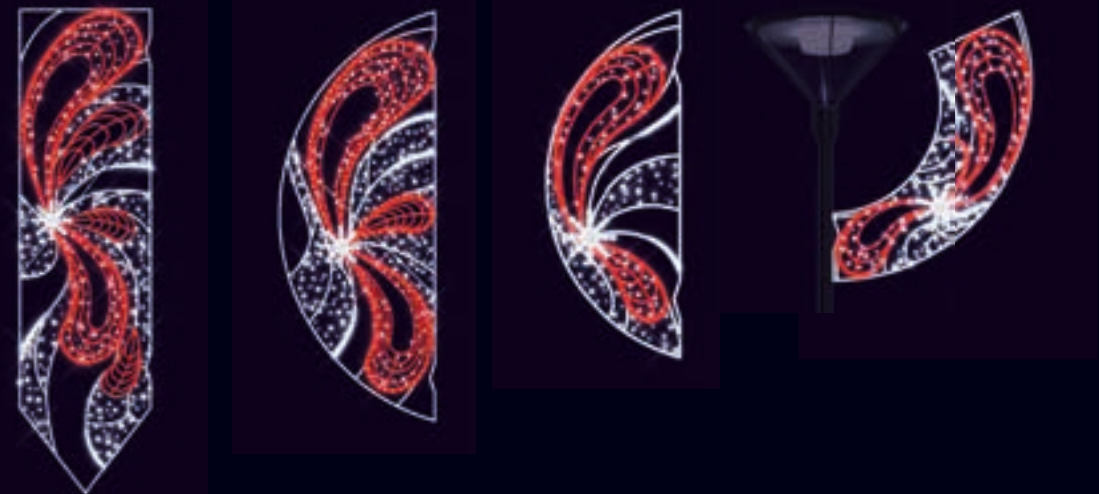

IPL202W IPL226W IPL203W IPL231W

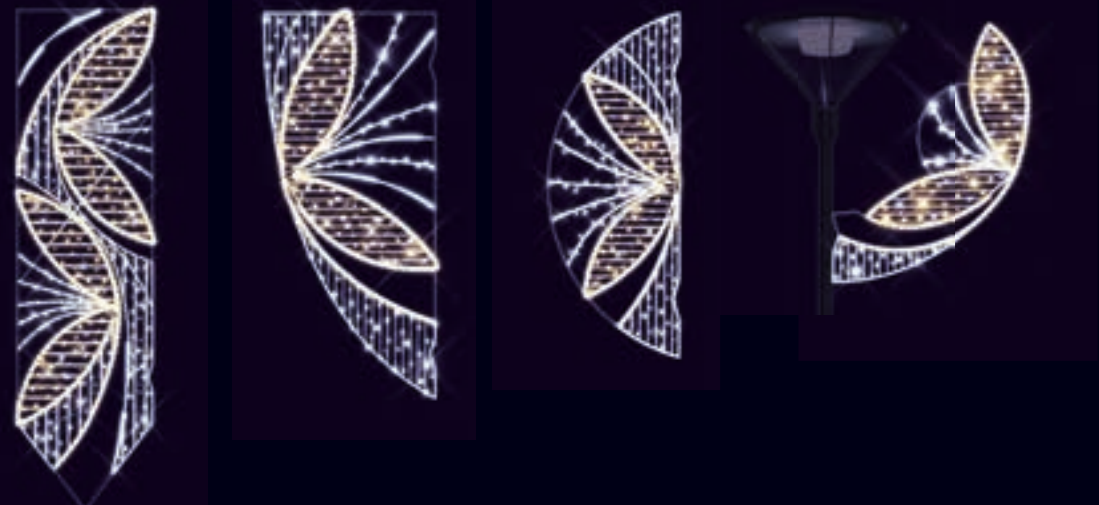

ITL321R **N**



ITL321R + 1 TSL2

ITL226W



ITL218W

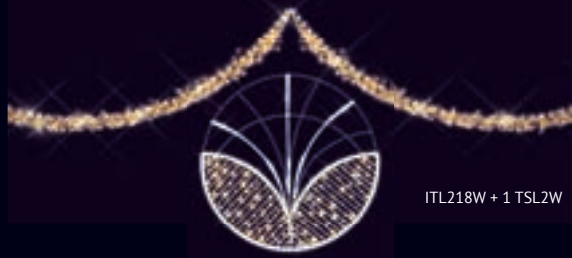

ITL218W + 1 TSL2W



ITL321R / IPL318R



IPL317R



ITL218W / IPL226W

<p>IPL317R- DROP BANNER</p> <p>2.8m x 0.8m 11kg 48W</p> <p>● SLOWFLASH & SOFT XLED 14</p> <p>TO ORDER</p>	<p>IPL318R- DROP GRAND</p> <p>2.3m x 0.9m 8kg 40W</p> <p>● SLOWFLASH & SOFT XLED 16</p>	<p>IPL320R- DROP PETIT</p> <p>1.5m x 0.6m 6kg 32W</p> <p>● SLOWFLASH & SOFT XLED 5</p>	<p>IPL319R- DROP ROLL</p> <p>1.9m x 1.0m 6kg 36W</p> <p>● SLOWFLASH & SOFT XLED 56</p> <p>TO ORDER</p>	<p>ITL321R- DROP UNIT</p> <p>1.0m x 1.0m 8kg 42W</p> <p>● SLOWFLASH & SOFT XLED 69</p>	<p>ITL218W- COIMBRA UNIT</p> <p>1.0m x 1.0m 3.8kg 30W</p> <p>● XLED & FLASH 42</p>
<p>IPL202W- COIMBRA BANNER</p> <p>2.8m x 0.8m 12kg 60W</p> <p>● FLASH & XLED & SLOWFLASH 43</p>	<p>IPL226W- COIMBRA</p> <p>2.0m x 0.9m 7kg 40W</p> <p>● FLASH & XLED & SLOWFLASH 56</p>	<p>IPL203W- COIMBRA PETIT</p> <p>1.5m x 0.6m 4kg 20W</p> <p>● FLASH 22</p>	<p>IPL231W- COIMBRA ROLL</p> <p>1.2m x 0.9m 4.5kg 30W</p> <p>● FLASH & XLED & SLOWFLASH 36</p>	<p>ITL226W- COIMBRA DOUBLE</p> <p>0.9m x 4.0m 14.5kg 80W</p> <p>● XLED & FLASH & SLOWFLASH 111</p>	



IPL267W IPL266W IPL265W

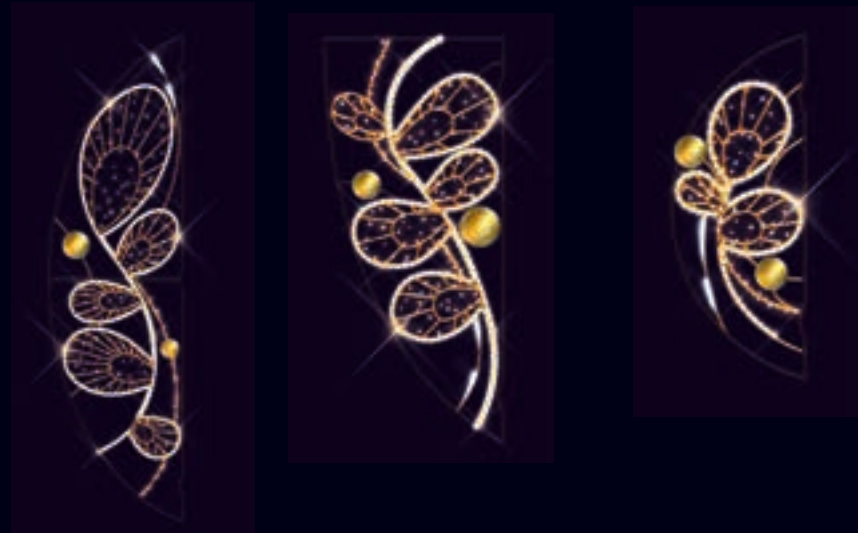

IPL031W IPL268W IPL082W

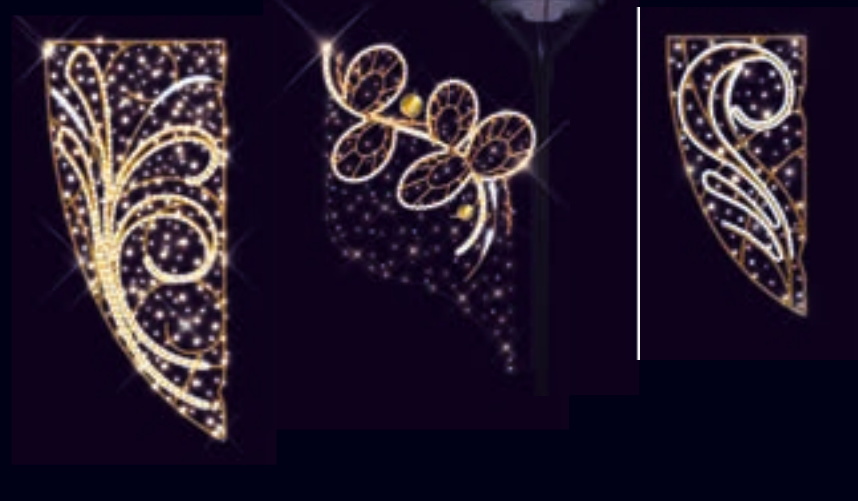

ITL266W



ITL165W



ITL077W



IPL267W-GRACE GRAND
 5.5m x 1.0m x 11.5kg 50W
 SLOWFLASH&XLED 18

IPL266W-GRACE PETIT
 2.0m x 0.9m x 6.5kg 40W
 SLOWFLASH&XLED 64

IPL265W-GRACE PETIT
 1.5m x 0.6m x 3.7kg 20W
 SLOWFLASH&XLED 38

ITL266W-GRACE DOUBLE
 0.9m x 4.0m x 12.7kg 80W
 SLOWFLASH&XLED 128

ITL077W-BOLCHOI
 1.2m x 6.0m x 25.3kg 160W
 XLED&SLOWFLASH 235

IPL031W-MAZURKA
 2.0m x 0.9m x 7.4kg 50W
 XLED&SLOWFLASH 53

IPL268W-GRACE ROLL
 1.7m x 1.1m x 5.5kg 35W
 SLOWFLASH&XLED 47

IPL082W-LIBRETTO
 1.2m x 0.6m x 3.5kg 30W
 XLED&SLOWFLASH 33

ITL165W-ILWAN
 1.0m x 1.0m x 15.3kg 105W
 XLED&SLOWFLASH 141



ITL165W

ITGL170LW



TGL169LW



ITGL100

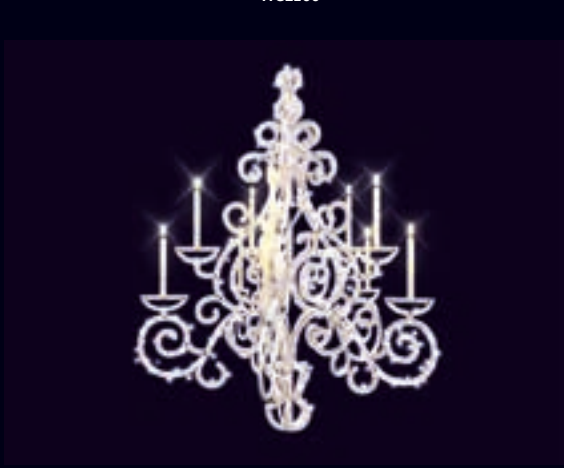

ITGL170L



GX114LW



ITGL101W



ITGL170LW

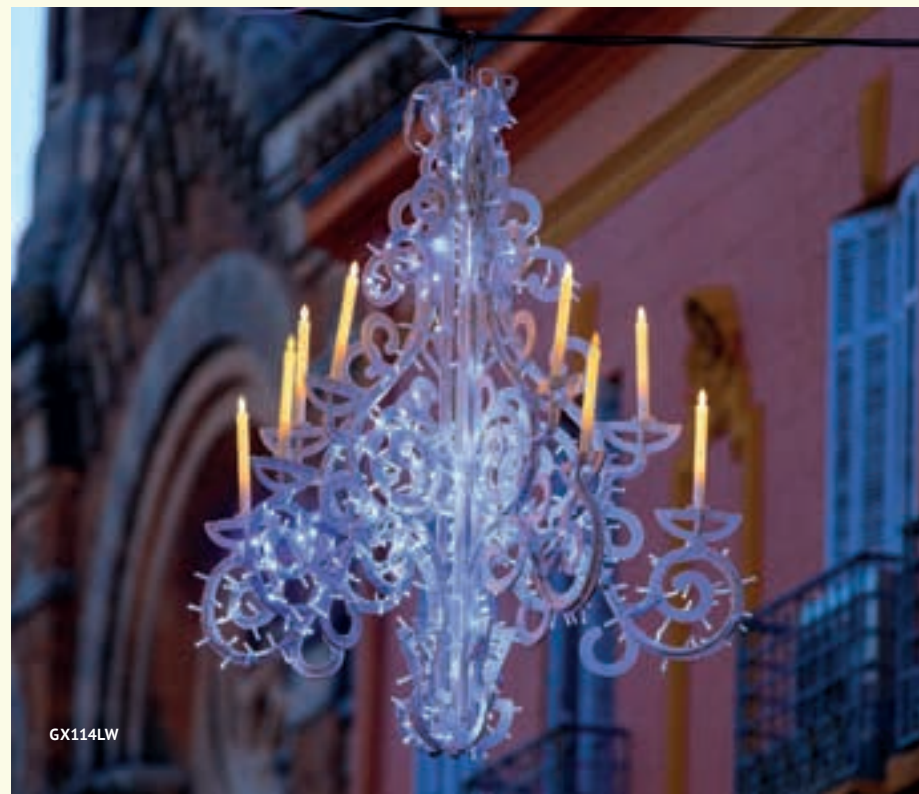

GX114LW



TGL169LW

ITGL170B- SPIRIT

◆ 2.0m ◆ 1.1m ▣ 1.1m 🧑 44kg ⚡ 87W

🟡 FLASH

TO ORDER

ITGL170L- SPIRIT

◆ 2.0m ◆ 1.1m ▣ 1.1m 🧑 44kg ⚡ 87W

🟡 FLASH

TO ORDER

TGL169LW- BAROQUE

◆ 1.4m ◆ 1.2m ▣ 1.2m 🧑 26kg ⚡ 135W

💡 13

GX114LW- JAVA

◆ 1.5m ◆ 1.2m ▣ 1.2m 🧑 27kg ⚡ 30W

🟡 FLASH 💡 78

ITGL100- CADENCE

◆ 1.5m ◆ 1.2m ▣ 1.2m 🧑 175kg ⚡ 55W

🟡 SLOWFLASH 💡 153

ITGL101W- NOELIE

◆ 1.0m ◆ 0.9m ▣ 1.2m 🧑 3.8kg ⚡ 20W

🟡 SLOWFLASH 💡 38



IPL311 N



IPL300B N



IPL300G N

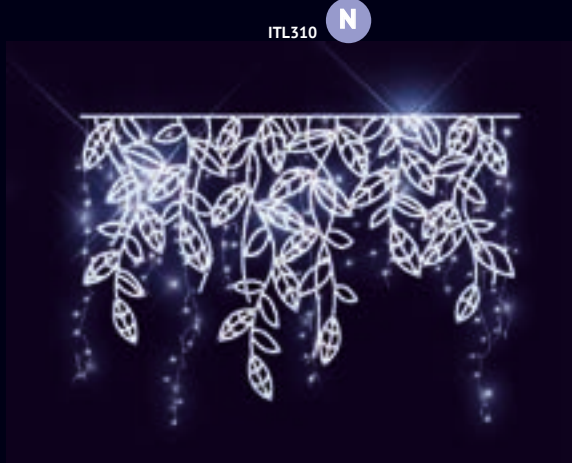

ITL310 N

IPL311W N



ITL310W N



IPL311-PLANT RING XMAS
 ◆ 1.0m ◀ 0.6m ▣ 0.6m ⚖ 6kg ⚡ 7W
 ● FLASH 🕒 24

IPL300B-PLANT XMAS
 ◆ 1.9m ◀ 0.3m ▣ 0.3m ⚖ 0.42kg ⚡
 ● FLASH 🕒 14

ITL310-PLANT LINE XMAS
 ◆ 0.8m ◀ 1.2m ▣ 0.7kg ⚡ 5W
 ● FLASH 🕒 24

IPL311W-PLANT RING XMAS
 ◆ 1.0m ◀ 0.6m ▣ 0.6m ⚖ 6kg ⚡ 7W
 ● FLASH 🕒 24

IPL300W-PLANT XMAS
 ◆ 1.2m ◀ 0.5m ▣ 0.4kg ⚡
 ● FLASH 🕒 14

ITL310W-PLANT LINE XMAS
 ◆ 0.8m ◀ 1.2m ▣ 0.7kg ⚡ 5W
 ● FLASH 🕒 24



ITL311 / IPL311

IPL135

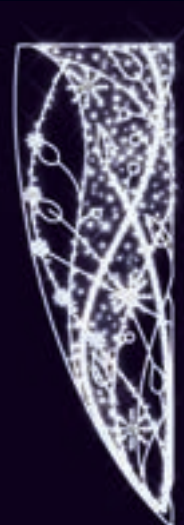

IPL075B



IPL110



IPL135W



IPL075W



IPL110W



ITL021



ITL021 + 1 TSL2

ITL135



ITL135W

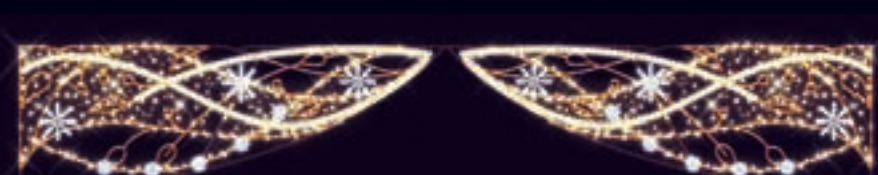

IPL075W



IPL135W



ITL021



IPL135-FLORA
 3.0m x 1.0m x 0.9m | 13.3kg | 70W
 STARS & SLOWFLASH | 94

IPL075B-ZEPHYR
 2.5m x 0.9m x 0.9m | 8.2kg | 60W
 XLED & SLOWFLASH | 76

IPL110-ASTERIE
 2.0m x 0.9m x 0.9m | 5.1kg | 30W
 SLOWFLASH | 6

ITL021-AIGUILLE
 1.3m x 1.3m x 0.9m | 4.6kg | 55W
 SLOWFLASH | 65

ITL135W-FLORA DOUBLE
 1.0m x 6.0m x 0.9m | 26kg | 130W
 STARS & SLOWFLASH | 187

IPL135W-FLORA
 3.0m x 1.0m x 0.9m | 13.3kg | 70W
 STARS & SLOWFLASH | 94

IPL075W-ZEPHYR
 2.5m x 0.9m x 0.9m | 8.2kg | 60W
 XLED & SLOWFLASH | 76

IPL110W-ASTERIE
 2.0m x 0.9m x 0.9m | 5.1kg | 30W
 SLOWFLASH | 6

ITL135-FLORA DOUBLE
 1.0m x 6.0m x 0.9m | 26kg | 130W
 STARS & SLOWFLASH | 187

Precious

The Precious collection is inspired by the world of jewellery and fashion.

The design's lines echo those of items of jewellery: long necklaces, pendants and pearls are all refined references found in this theme.

A symbol of Christmas par excellence, the bow evokes connection, sharing and the joy of gifting, imposing its precious and timeless style.

- JEWELLERY
- LINKS
- ADORNMENT
- FASHION
- BOW
- RIBBONS

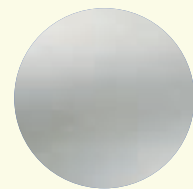
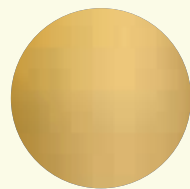
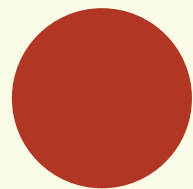
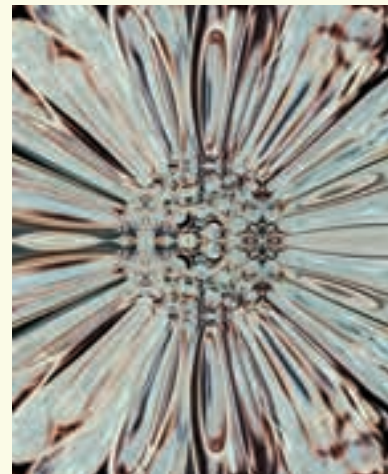

IPL332W + IPL334W **N** IPL332W **N** IPL333W **N**



IPL328W **N** IPL329W **N** IPL330W **N**

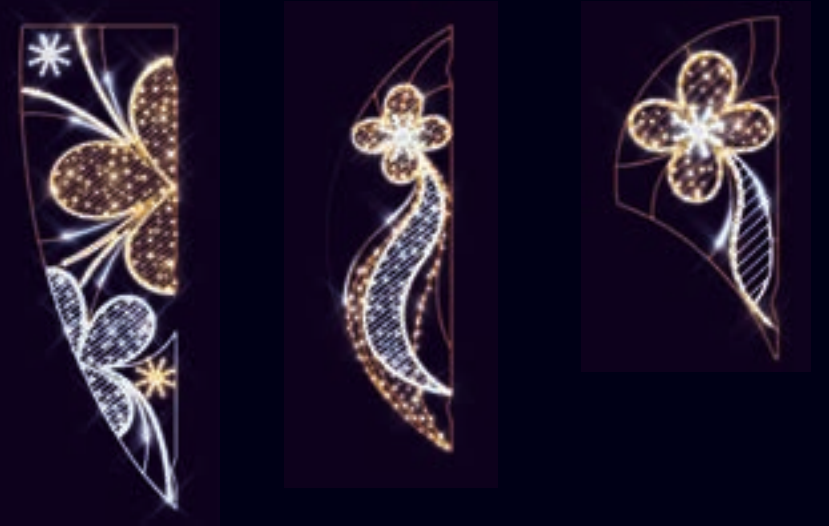

ITL333W **N**



ITL332W **N** ITL332W + 1 TSL2W

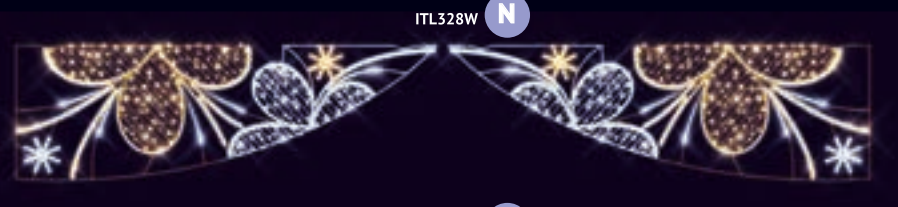

ITL331W **N**



ITL331W + 1 TSL2W



ITL332W / IPL333W



ITL333W



ITL331W / IPL334W



ITL333W

IPL332W-DANDY

◀0.6m ▶1.0m ▲7kg ⚡34W
 ●●● SLOWFLASH & SOFT XLED 67

IPL328W-LUCKY GRAND

◀3.0m ▶1.0m ▲14kg ⚡93W
 ●●● SLOWFLASH & SOFT XLED 95

IPL333W-DANDY DRAPEAU

◀2.0m ▶0.9m ▲9kg ⚡55W
 ●●● SLOWFLASH & SOFT XLED 118

ITL333W-DANDY DOUBLE

◀0.9m ▶4.0m ▲17kg ⚡110W
 ●●● SLOWFLASH & SOFT XLED 237

ITL328W-LUCKY DOUBLE

◀1.0m ▶6.0m ▲28kg ⚡185W
 ●●● SLOWFLASH & SOFT XLED 189

IPL334W-DANDY POLE

◀1.0m ▶0.2m ▲3kg ⚡4W
 ●●● 22

IPL329W-LUCKY

◀2.5m ▶0.7m ▲9kg ⚡38W
 ●●● SLOWFLASH & SOFT XLED 69

IPL330W-LUCKY PETIT

◀1.5m ▶0.7m ▲5kg ⚡29W
 ●●● SLOWFLASH & SOFT XLED 41

ITL332W-DANDY UNIT

◀0.6m ▶1.0m ▲7kg ⚡34W
 ●●● FLASH 67

ITL331W-LUCKY UNIT

◀1.0m ▶0.9m ▲5kg ⚡25W
 ●●● 44





ITGL179WW-LANTERN BOHO 2
 ◆0.5m ◆0.5m ▣0.5m 🏠 4kg ⚡ 4W
 ●● EFFET FLAMME 🕯️
 TO ORDER
ITGL179BW-LANTERN BOHO 2
 ◆0.5m ◆0.5m ▣0.5m 🏠 4kg ⚡ 4W
 ●● EFFET FLAMME 🕯️
 TO ORDER

ITGL180WW-LANTERN BOHO 1
 ◆0.8m ◆0.4m ▣0.4m 🏠 5kg ⚡ 4W
 ●● EFFET FLAMME 🕯️ 45
 TO ORDER
ITGL180BW-LANTERN BOHO 1
 ◆0.8m ◆0.4m ▣0.4m 🏠 5kg ⚡ 4W
 ●● EFFET FLAMME 🕯️ 45
 TO ORDER

ITGL182WW-LANTERN BOHO 3
 ◆0.6m ◆0.4m ▣0.4m 🏠 3kg ⚡ 4W
 ●● EFFET FLAMME 🕯️
 TO ORDER
ITGL182BW-LANTERN BOHO 3
 ◆0.6m ◆0.4m ▣0.4m 🏠 3kg ⚡ 4W
 4 🕯️
 TO ORDER



IPL326W N IPL324W N IPL325W N

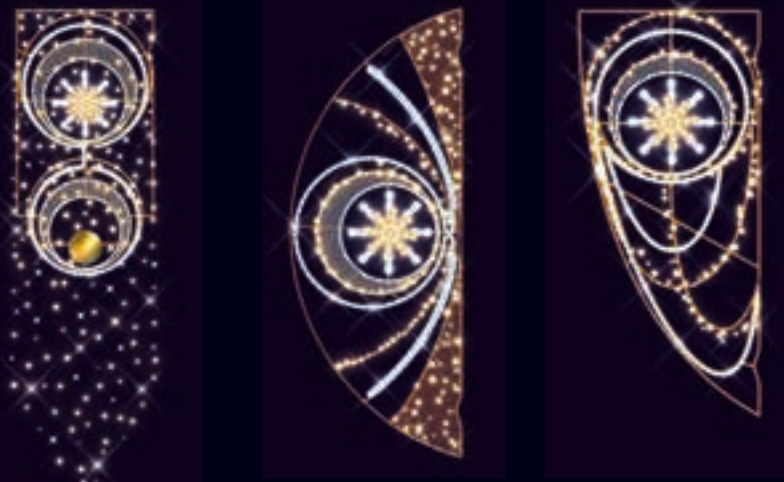

IPL087W IPL115W IPL272W

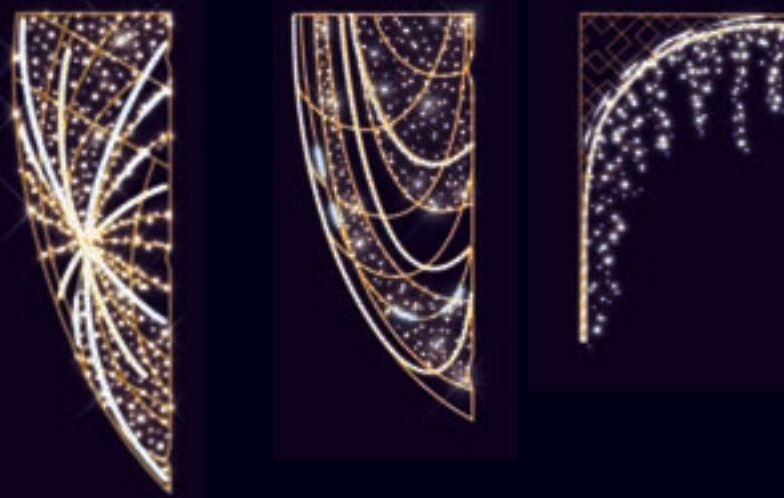

ITL327W N



ITL327W + 1 TSL2

ITL033W



ITL327W / IPL325W



IPL272W



ITL033W



IPL326W-BOHO BANNER
2.8m x 0.8m | 11kg | 41W
FLASH 82

IPL324W-BOHO GRAND
2.3m x 0.9m | 10kg | 43W
FLASH 83

IPL325W-BOHO
2.0m x 0.9m | 10kg | 45W
FLASH 77

ITL327W-BOHO UNIT
1.0m x 0.8m | 5kg | 24W
FLASH 48

ITL033W-RHAPSODY DOUBLE
1.6m x 6.0m | 28.6kg | 185W
FLASH 235
TO ORDER

IPL087W-LIANO
3.0m x 1.0m | 12.8kg | 95W
XLED&SLOWFLASH 76

IPL115W-LYRE
2.0m x 0.9m | 6.1kg | 40W
SLOWFLASH&XLED 63

IPL272W-RIALTO
1.5m x 1.0m | 3kg | 25W
FLASH&XLED 26

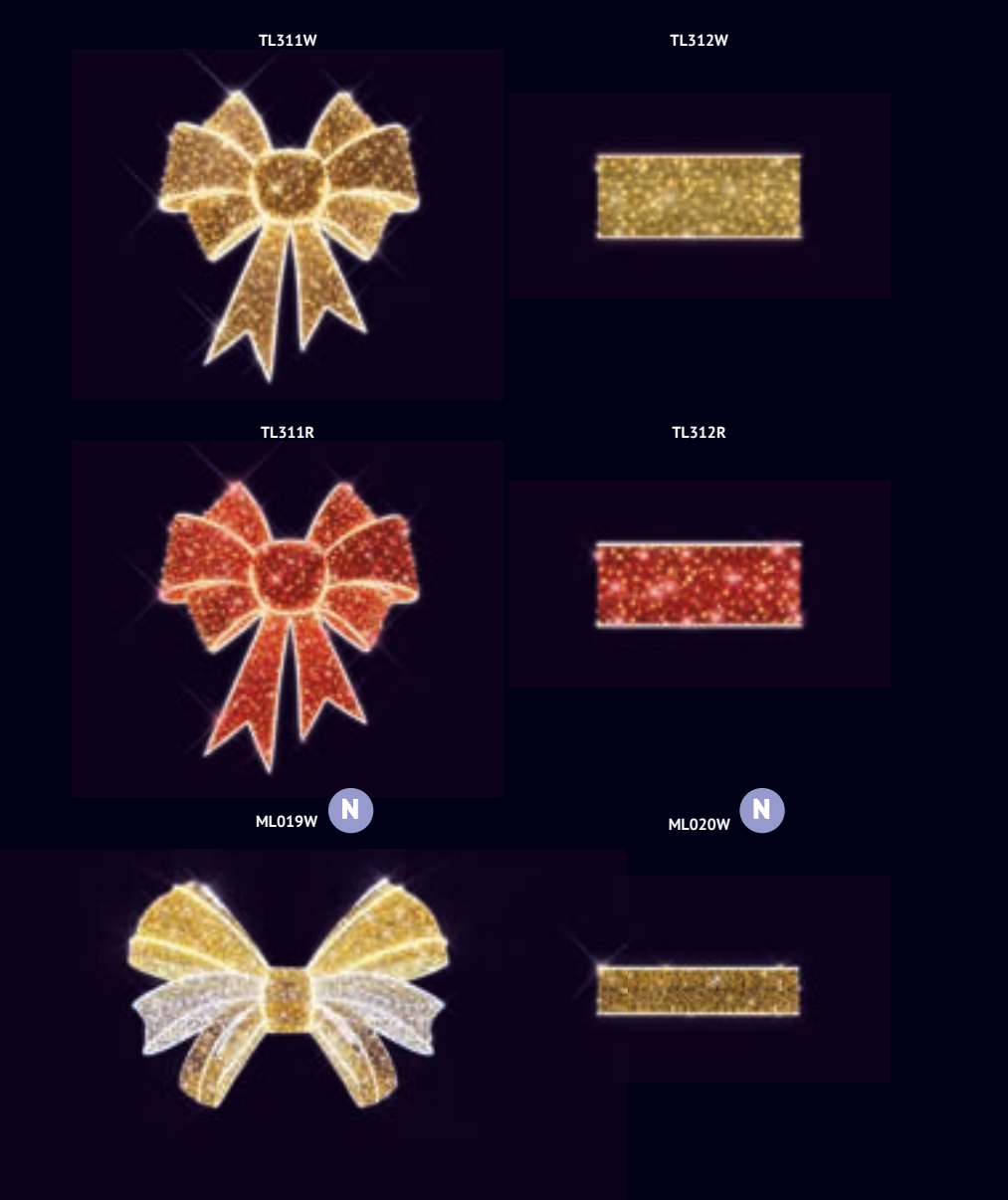
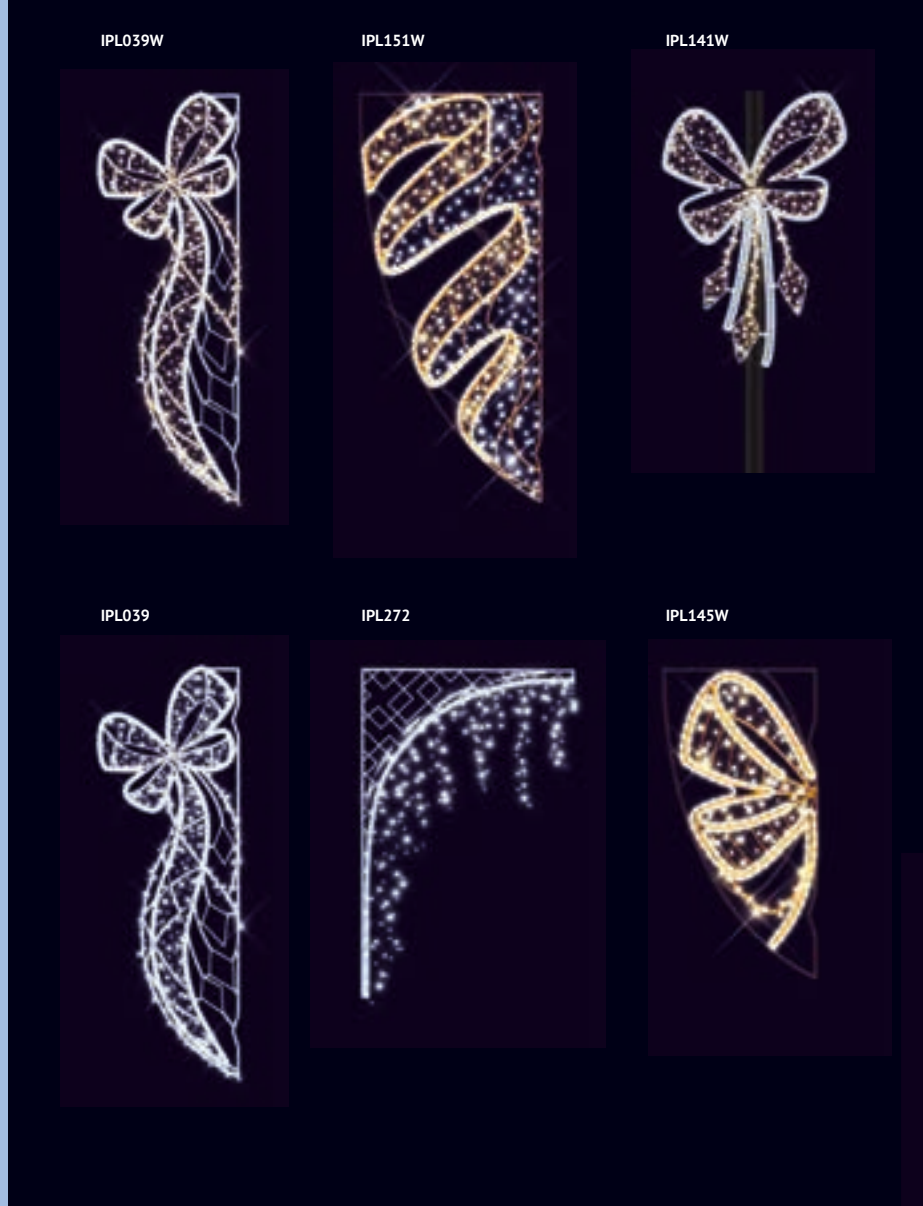

<p>IPL039W-PENELOPE</p> <p>◆2.0m ◆0.7m ▲5.9kg ↻35W</p> <p>FLASH 61</p>	<p>IPL151W-CASCADE</p> <p>◆2.0m ◆0.9m ▲7.6kg ↻45W</p> <p>SLOWFLASH 25</p>	<p>IPL141W-ILIADE</p> <p>◆1.0m ◆0.7m ▲3.4kg ↻25W</p> <p>FLASH 31</p>	<p>TL311W-CLEA</p> <p>◆2.1m ◆1.8m ▲0.5m ▲22kg ↻45W</p> <p>FLASH</p>	<p>ML019W-DANDY XL</p> <p>◆1.4m ◆2.0m ▲0.5m ▲18kg ↻152W</p> <p>SOFT XLED</p> <p>TO ORDER</p>	<p>TL312W-CLEO RUBAN</p> <p>◆0.8m ◆2.0m ▲8kg ↻45W</p> <p>FLASH</p> <p>TO ORDER</p>
<p>IPL039-PENELOPE</p> <p>◆2.0m ◆0.7m ▲5.9kg ↻35W</p> <p>SLOWFLASH 61</p>	<p>IPL272-RIALTO</p> <p>◆1.5m ◆1.0m ▲3kg ↻25W</p> <p>FLASH&XLED 26</p>	<p>IPL145W-LIV PETIT</p> <p>◆1.2m ◆0.6m ▲3.7kg ↻25W</p> <p>SLOWFLASH 29</p>	<p>TL311R-CLEO</p> <p>◆2.1m ◆1.8m ▲0.5m ▲22kg ↻45W</p> <p>FLASH</p> <p>TO ORDER</p>	<p>TL312R-CLEA RUBAN</p> <p>◆0.8m ◆2.0m ▲0.0m ▲8kg ↻45W</p> <p>FLASH</p>	<p>ML020W-DANDY RUBAN</p> <p>◆0.4m ◆2.0m ▲5kg ↻27W</p> <p>FLASH</p>



ITL311W



COSY

Close your eyes and breathe in the delicious scent of cinnamon that fills the alleyways of the Christmas market. Pine green, red and gold are the key colours in this collection, which has a warm, traditional and gourmand feel. Lanterns of every variety are an integral part of this Cosy collection, an ode to festive winter traditions with family and friends.

- TRADITION
- WARM
- COCOONING
- PINE TREES
- CANDLE
- LANTERNS

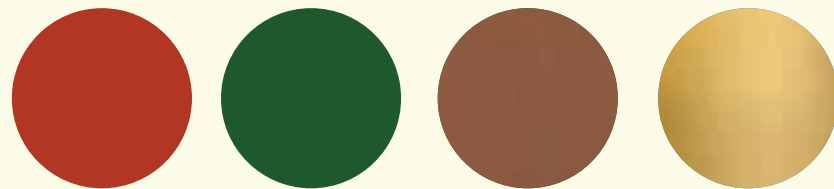

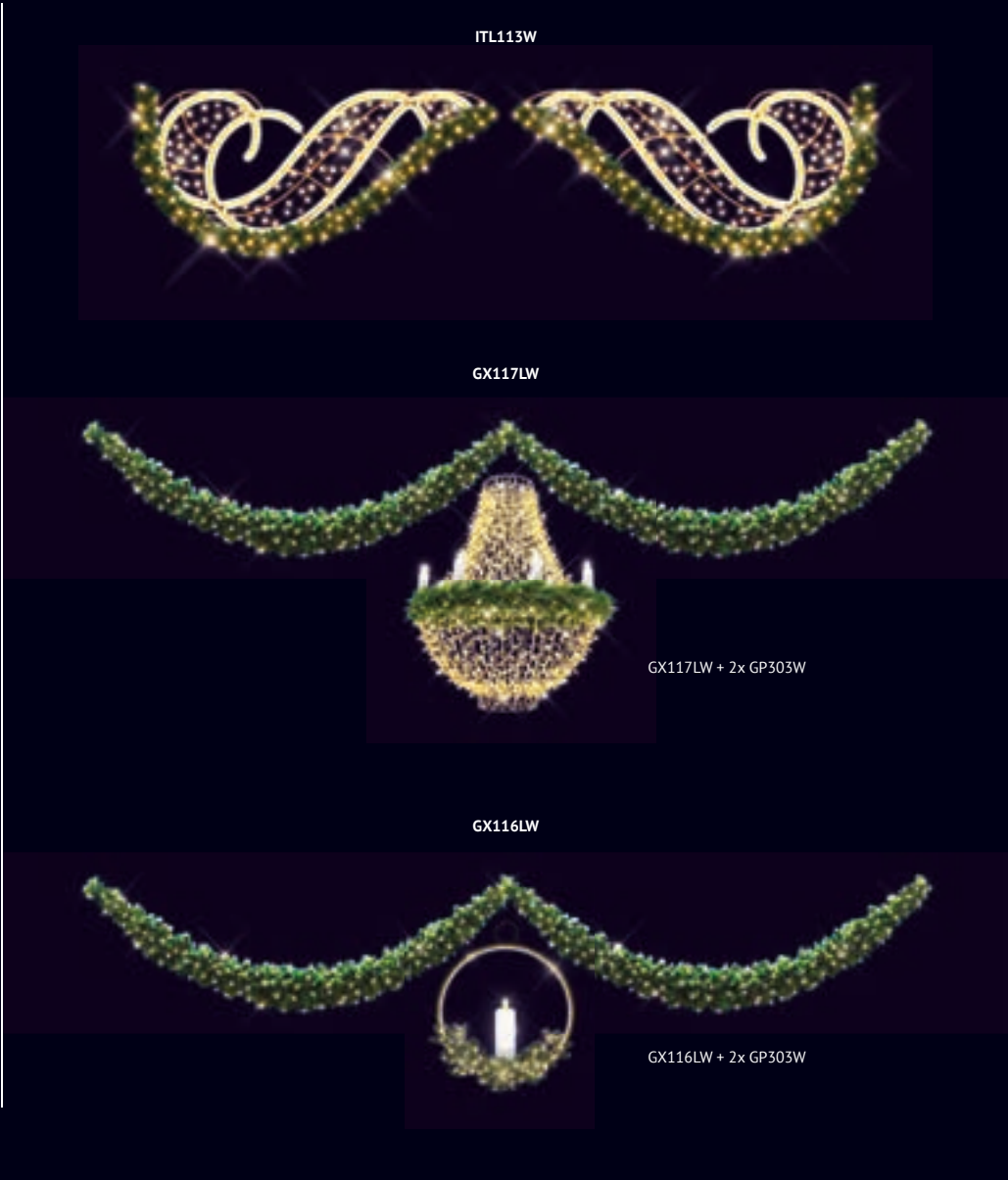
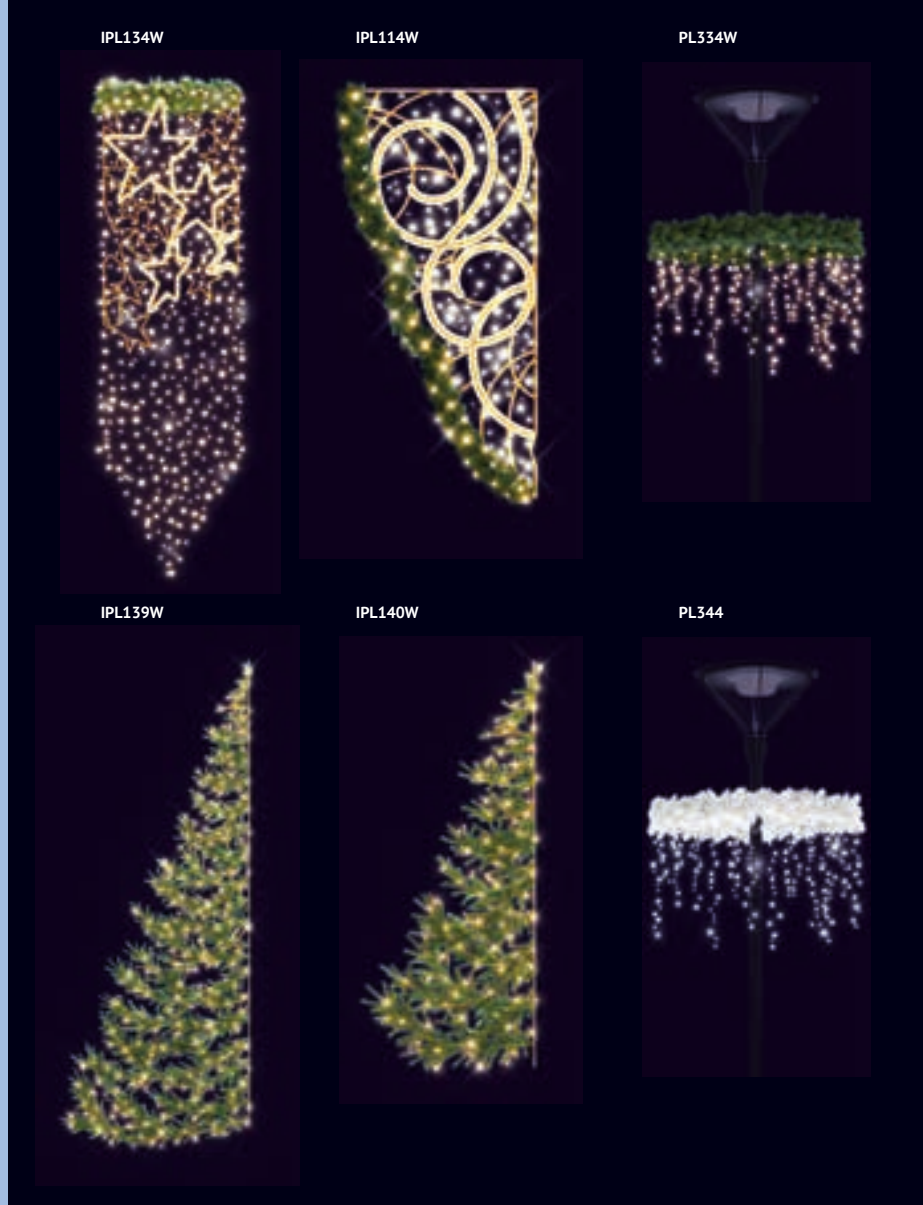

<p>IPL134W-OLYMPÉ BANNER</p> <p>2.8m x 0.8m 9.7kg 50W</p> <p>● SLOWFLASH 63</p>	<p>IPL114W-ZOE</p> <p>2.0m x 0.9m 8.7kg 65W</p> <p>● SLOWFLASH 57</p>	<p>PL344W-BOA</p> <p>0.6m x 1.0m x 1.0m 5.3kg 10W</p> <p>● FLASH</p>	<p>ITL113W-CALYPSO DOUBLE</p> <p>0.9m x 4.0m 15.1kg 110W</p> <p>● SLOWFLASH 82</p>	<p>GX116LW-ACHILLE</p> <p>0.7m x 0.6m 5.6kg 15W</p> <p>● ANIME BOUGIE</p>
<p>IPL139W-NORDIKA 2D - GM</p> <p>3.0m x 1.2m 13.6kg 40W</p> <p>● SLOWFLASH 43</p>	<p>IPL140W-NORDIKA 2D - PM</p> <p>1.6m x 0.7m 6.5kg 20W</p> <p>● SLOWFLASH 21</p>	<p>PL344-BOA</p> <p>0.6m x 1.0m x 1.0m 5.3kg 10W</p> <p>● FLASH</p>	<p>GX117LW-ULYSSE</p> <p>2.0m x 1.5m x 1.5m 25.6kg 130W</p> <p>● SLOWFLASH 11</p>	



GX117LW

IPL271R



IPL271W



IPL270R



IPL270W



IPL271R- COSY PETIT

1.5m 0.6m 3.5kg 30W
SLOWFLASH 28

IPL271W- COSY PETIT

1.5m 0.6m 3.5kg 30W
SLOWFLASH 28

ITL276R- COSY STAR UNIT

1.0m 0.9m 2.7kg 20W
SLOWFLASH 38

ITL279W- COSY BALL UNIT

1.0m 0.8m 3.3kg 20W
SLOWFLASH 40

ITL279R- COSY BALL UNIT

1.0m 0.8m 3.3kg 20W
SLOWFLASH 40

ITL276W- COSY STAR UNIT

1.0m 0.9m 2.7kg 20W
SLOWFLASH 38

IPL270R- COSY

2.0m 0.9m 6kg 40W
SLOWFLASH 43

IPL270W- COSY

2.0m 0.9m 6kg 40W
SLOWFLASH 43

ITL275R- COSY UNIT

1.0m 0.8m 3.2kg 20W
SLOWFLASH 40

ITL278W- COSY TREE UNIT

1.0m 0.8m 2.5kg 20W
SLOWFLASH 55

ITL277W- COSY ANGEL UNIT

1.0m 0.6m 2.4kg 20W
SLOWFLASH 38

ITL276R



ITL276R + 2x GP303W

ITL279W



ITL279W + 2x GP303W

ITL275R



ITL275R + 2x GP303W

ITL278W



ITL278W + 2x GP303W

ITL277W



ITL277R + 2x GP303W

ITL276W



ITL276W + 2x GP303W



ITL275R / IPL271W / IPL271R



ITL276R / ITL275R / ITL279R





<p>IPL076W- CASSIOPEE</p> <p>◆ 3.0m ◆ 1.0m ▣ 12.2kg ⚡ 60W</p> <p>■ XLED&SLOWFLASH 94</p>	<p>IPL076- CASSIOPEE</p> <p>◆ 3.0m ◆ 1.0m ▣ 12.2kg ⚡ 60W</p> <p>■ XLED&SLOWFLASH 94</p>	<p>IPL081W- SAMBA</p> <p>◆ 2.5m ◆ 1.3m ▣ 6.9kg ⚡ 45W</p> <p>■ XLED&SLOWFLASH 43</p>	<p>ITL076W- CASSIOPEE DOUBLE</p> <p>◆ 1.0m ◆ 6.0m ▣ 23.4kg ⚡ 120W</p> <p>■ XLED&SLOWFLASH 187</p>	<p>FCL080G-E</p> <p>◆ 0.8m ◆ 0.8m ▣ 0.8m 2.2kg ⚡ 15W</p> <p>■</p>
<p>IPL070B- TWISTER</p> <p>◆ 2.0m ◆ 0.9m ▣ 6.5kg ⚡ 35W</p> <p>■ STARS&SLOWFLASH 51</p>	<p>IPL070W- TWISTER</p> <p>◆ 2.0m ◆ 0.9m ▣ 6.5kg ⚡ 35W</p> <p>■ STARS&SLOWFLASH 51</p>	<p>VL045W- BLIZZARD VL</p> <p>◆ 3.0m ◆ 2.2m ▣ 2.2m 29kg ⚡ 105W</p> <p>■ XLED&FLASH 225</p>	<p>ITL009- JF</p> <p>◆ 0.9m ◆ 3.5m ▣ 10.9kg ⚡ 80W</p> <p>■ 16</p>	<p>ITL061- JF</p> <p>◆ 0.9m ◆ 3.5m ▣ 10.9kg ⚡ 80W</p> <p>■ 16</p>



ITL076W / IPL076W

2D

3D

3D

ITL053



ITGL104 / ITGL105



TGL70W / TGL71W / TGL72W

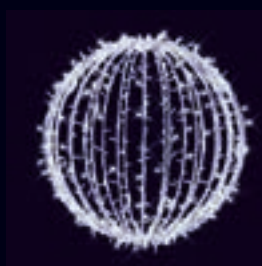

G-SPHER+



G-MONT+



ITL053W



ITGL104W / ITGL105W



TGL70WW / TGL71WW / TGL72WW



G-SPHERW+



G-MONTW+

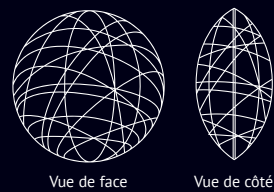

Vue de face / Vue de côté

TGL71LWCL

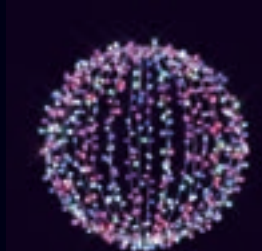

TGL71LWCL



G-MONT+ / G-SPHERW+



TGL71LW

ITL053- SPHERE GM

1.0m x 1.0m / 2.8kg 20W

FLASH 35

ITL053W- SPHERE GM

1.0m x 1.0m / 2.8kg 20W

SLOWFLASH 35

ITGL105- SPHERE FULL GM

0.8m x 0.8m x 0.4m / 3.2kg 20W

SLOWFLASH

ITGL104- SPHERE FULL MM

0.5m x 0.5m x 0.3m / 1.7kg 10W

SLOWFLASH

ITGL104W- SPHERE FULL MM

0.5m x 0.5m x 0.3m / 1.7kg 10W

SLOWFLASH

ITGL105W- SPHERE FULL GM

0.8m x 0.8m x 0.4m / 3.2kg 20W

SLOWFLASH

TGL71LW- SPHERE PLIABLE MM

1.0m x 1.0m x 1.0m / 11.5kg 75W

FLASH

TGL71LWW- SPHERE PLIABLE MM

1.0m x 1.0m x 1.0m / 11.5kg 75W

FLASH

TGL70LW- SPHERE PLIABLE PM

0.6m x 0.6m x 0.6m / 3.9kg 30W

FLASH

TGL71LWCL- CHERRY LIGHT SPHERE

1.0m x 1.0m x 1.0m / 11.5kg 15W

FLASH

G-SPHER+- SPHERE

0.6m x 0.6m x 0.6m / 2.3kg 12W

FLASH

TGL70LWW- SPHERE PLIABLE PM

0.6m x 0.6m x 0.6m / 3.9kg 30W

FLASH

G-SPHERW+- SPHERE

0.6m x 0.6m x 0.6m / 2.3kg 12W

FLASH

G-MONT+- MONTGOLFIÈRE

0.6m x 0.6m x 0.6m / 2.3kg 12W

FLASH

TGL72LW- SPHERE PLIABLE GM

1.6m x 1.6m x 1.6m / 24.8kg 165W

FLASH

G-MONTW+- MONTGOLFIÈRE

0.6m x 0.6m x 0.6m / 2.3kg 12W

FLASH

TGL72LWW- SPHERE PLIABLE GM

1.6m x 1.6m x 1.6m / 24.8kg 165W

FLASH

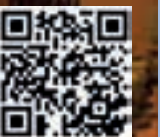



<p>ITGL141-ALTO</p> <p>◆1.0m ◀1.0m ▣0.4m ▲5.1kg ⚡35W</p> <p>●●●</p> <p>ITGL117R-LOVE</p> <p>◆0.6m ◀0.6m ▣0.5m ▲2kg ⚡8W</p> <p>■●</p>	<p>ITGL131-GOUTTE</p> <p>◆0.8m ◀0.4m ▣0.3m ▲1.8kg ⚡10W</p> <p>●●●</p> <p>ITGL131W-GOUTTE</p> <p>◆0.8m ◀0.4m ▣0.3m ▲1.8kg ⚡10W</p> <p>■●</p>	<p>ITGL111-STAR 7</p> <p>◆0.8m ◀0.8m ▣0.2m ▲1.9kg ⚡15W</p> <p>●●●</p> <p>ITGL111W-STAR 7</p> <p>◆0.8m ◀0.8m ▣0.2m ▲1.9kg ⚡15W</p> <p>■●</p>	<p>ITGL102-DIAMS</p> <p>◆0.6m ◀0.4m ▣0.2m ▲1.5kg ⚡15W</p> <p>●●●</p> <p>ITGL102W-DIAMS</p> <p>◆0.6m ◀0.4m ▣0.2m ▲1.5kg ⚡15W</p> <p>■●</p>
--	---	---	---



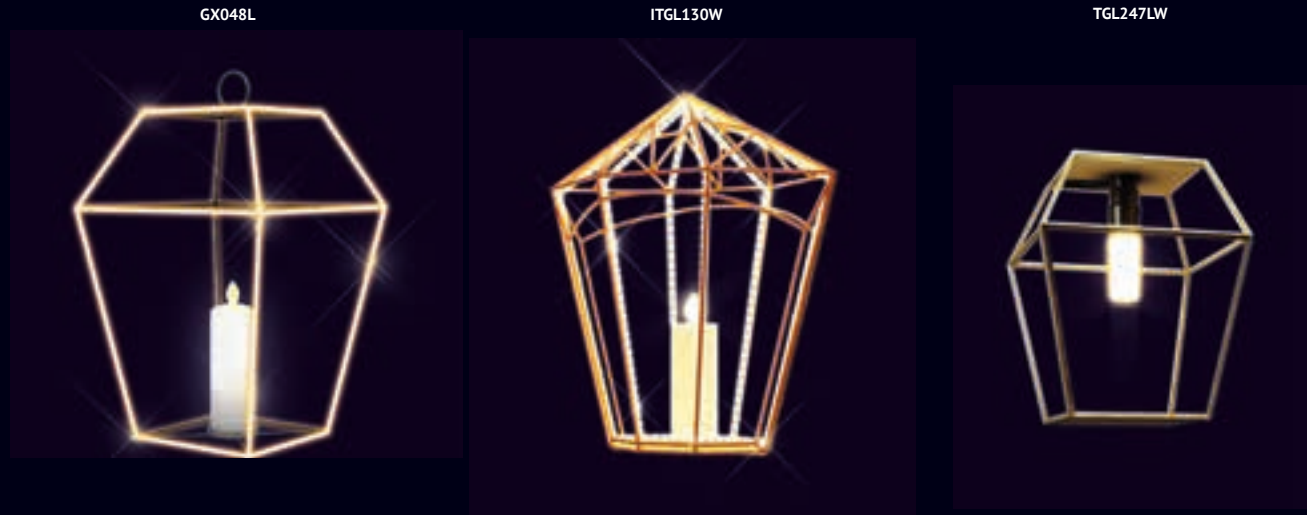

GX048L

ITGL130W

TGL247LW

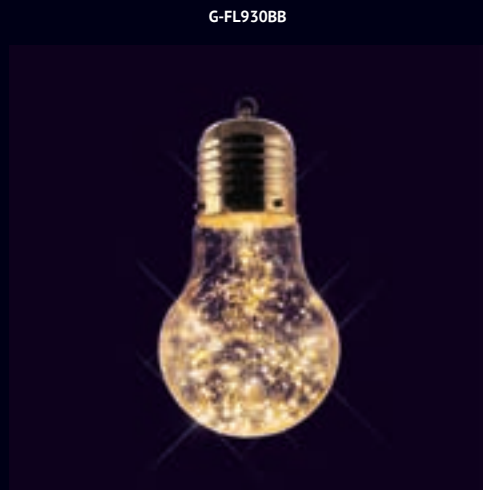

G-FL930BB



TL347W

2D

GX048LW-AURORA
 ◆0.7m ◆0.5m ▣0.5m 🏠4.3kg ⚡40W
 ●

ITGL130W-LANTERNA
 ◆0.7m ◆0.7m ▣0.4m 🏠2.9kg ⚡25W
 ● ●

TGL247LW-LUZ
 ◆0.4m ◆0.3m ▣0.3m 🏠1.3kg ⚡5W
 ●

G-FL930BB-NOSTALGIA
 ◆0.5m ◆0.2m ▣0.2m 🏠0.9kg ⚡4W
 ●

TL347W-LANTERN
 ◆1.0m ◆0.8m 🏠2.8kg ⚡20W
 ● STARS



G-FL930BB



ITGL130W



GX048L

Cristal

The Cristal collection brings a breath of freshness to your polar decoration. Delicate arabesques and more decorative lines warm up this glacial world. New snowflakes with softer designs in warm shades, mixing pure white and warm white, make up this range inspired by the nomadic peoples of the Far North.

- POLAR
- MOUNTAINS
- FROSTY ATMOSPHERE
- SNOWFLAKES
- BLIZZARD
- ARCTIC

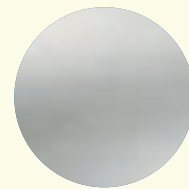
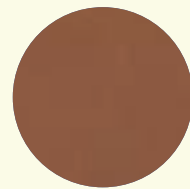
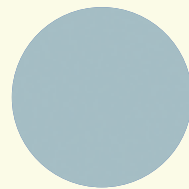
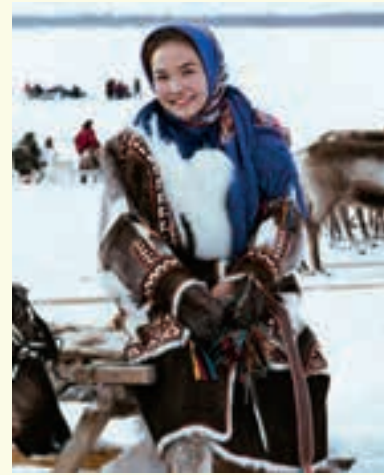

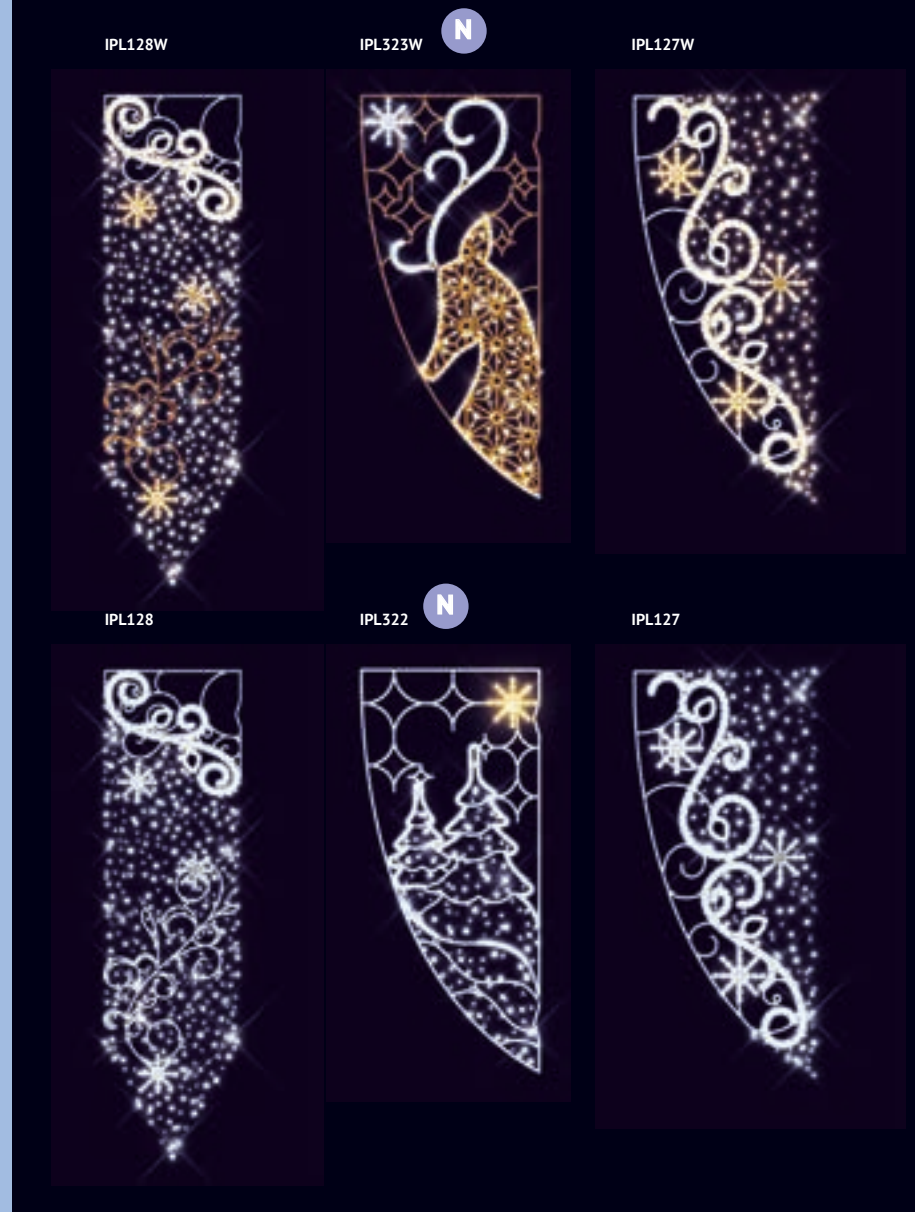

<p>IPL128W- MILO BANNER</p> <p>2.8m x 0.8m 8.8kg 50W</p> <p>STARS&FLASH 43</p>	<p>IPL323W- JOEL</p> <p>2.0m x 0.9m 7kg 37W</p> <p>FLASH 67</p>	<p>IPL127W- MILO</p> <p>2.0m x 0.9m 7.2kg 50W</p> <p>STARS&FLASH 41</p>	<p>ITL127W- MILO ARC</p> <p>1.2m x 4.0m 17.4kg 110W</p> <p>STARS&FLASH 116</p> <p>TO ORDER</p>	<p>ITL127- MILO ARC</p> <p>1.2m x 4.0m 17.4kg 110W</p> <p>STARS&FLASH 116</p>
<p>IPL128- MILO BANNER</p> <p>2.8m x 0.8m 8.8kg 50W</p> <p>STARS&FLASH 43</p>	<p>IPL322- WOODY</p> <p>2.0m x 0.9m 6kg 34W</p> <p>FLASH 52</p>	<p>IPL127- MILO</p> <p>2.0m x 0.9m 7.2kg 50W</p> <p>STARS&FLASH 41</p>	<p>ITL232W- LINE JF</p> <p>1.0m x 4.0m 17kg 120W</p> <p>XLED&STARS 83</p>	<p>ITL232W- JF VOLUTUS</p> <p>1.2m x 4.9m 23.6kg 155W</p> <p>FLASH&STARS 132</p>



IPL325W

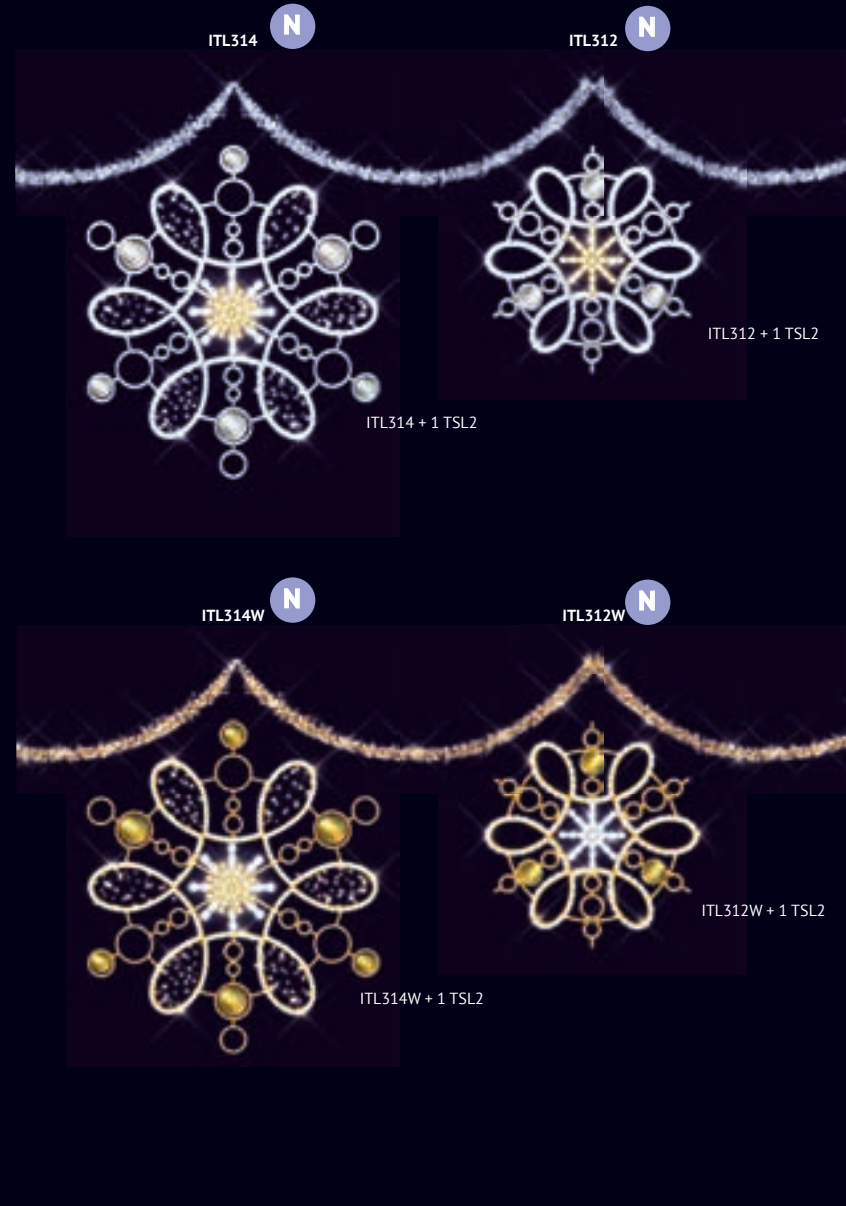
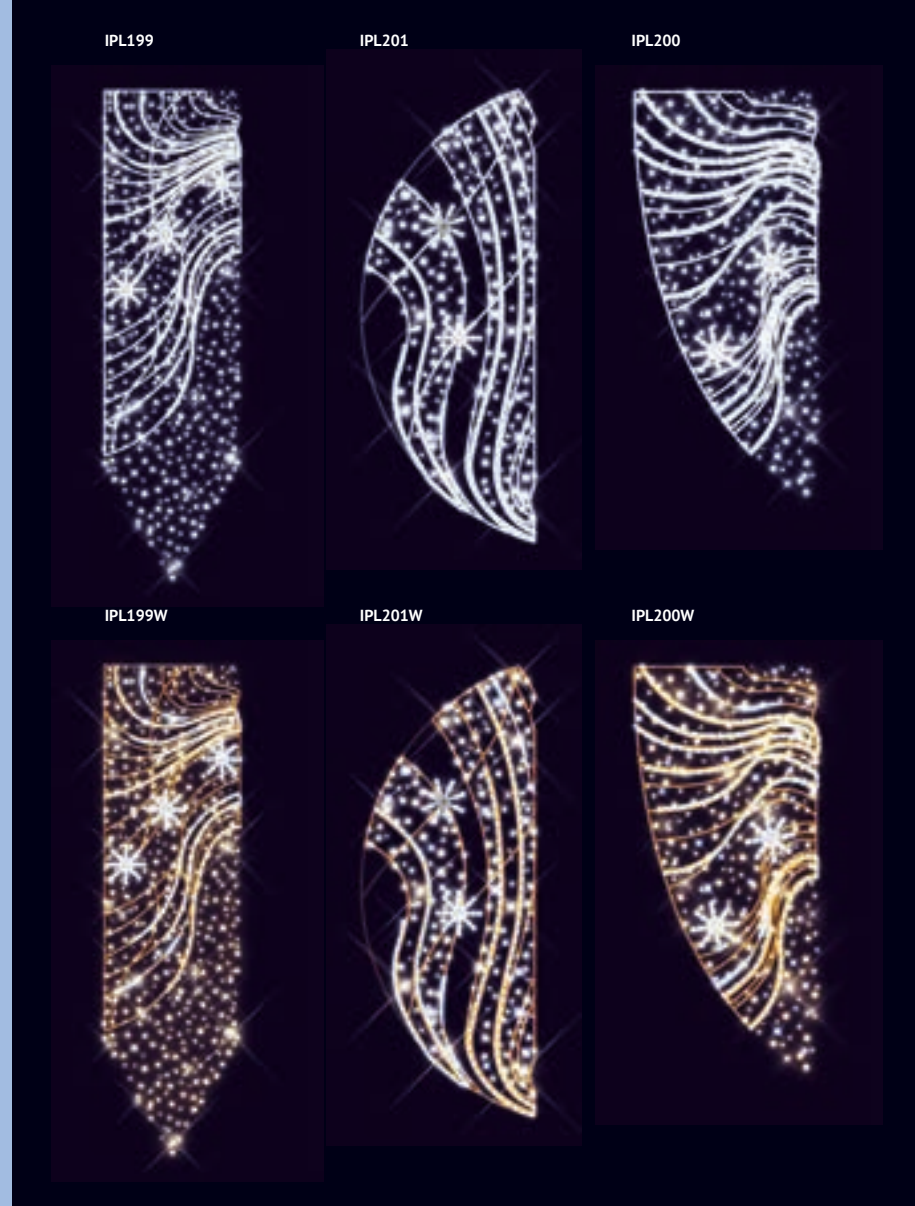

IPL199-LINE BANNER

2.8m 0.8m 10.8kg 60W
FLASH&XLED&STARS 83

IPL201-LINE GRAND

2.3m 0.9m 8.5kg 50W
FLASH&XLED&STARS 67

IPL200-LINE DRAPEAU

2.0m 0.9m 8.5kg 50W
FLASH&XLED&STARS 67

ITL314-WALLIS GRAND

1.6m 1.4m 9kg 42W
FLASH&STARS 57

ITL312-WALLIS

0.8m 0.8m 2.5kg 20W
STARS 32

IPL199W-LINE BANNER

2.8m 0.8m 10.8kg 60W
FLASH&XLED&STARS 83

IPL201W-LINE GRAND

2.3m 0.9m 8.5kg 50W
FLASH&XLED&STARS 67

IPL200W-LINE DRAPEAU

2.0m 0.9m 8.5kg 50W
FLASH&XLED&STARS 67

ITL314W-WALLIS GRAND

1.6m 1.4m 9kg 42W
FLASH&STARS 57

ITL312W-WALLIS

0.8m 0.8m 2.5kg 20W
STARS 32



ITL312W / ITL314W + GP303W / PIX05B

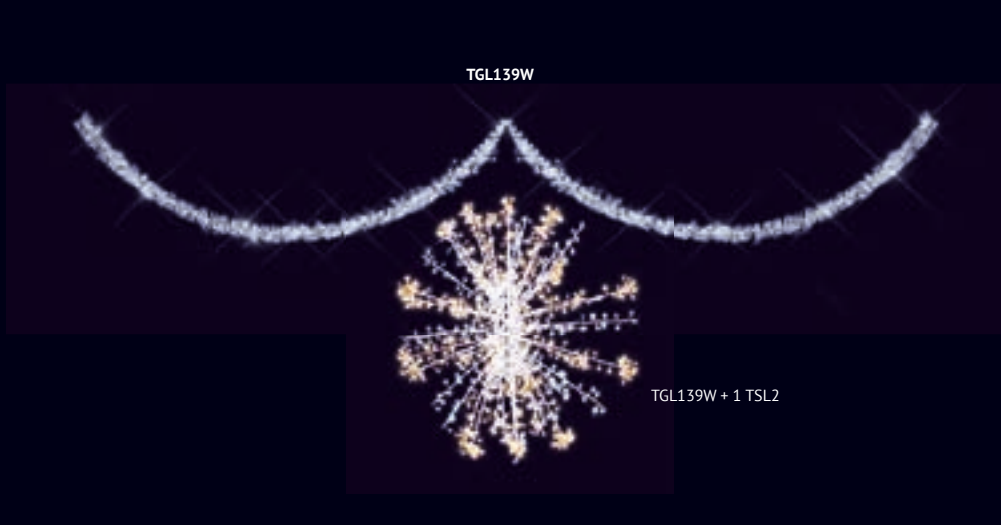
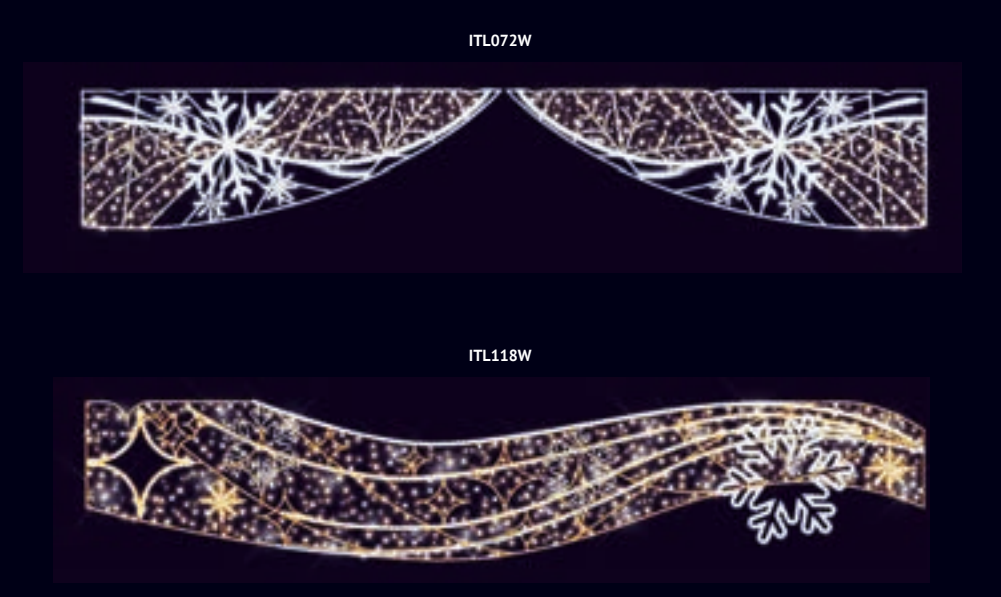
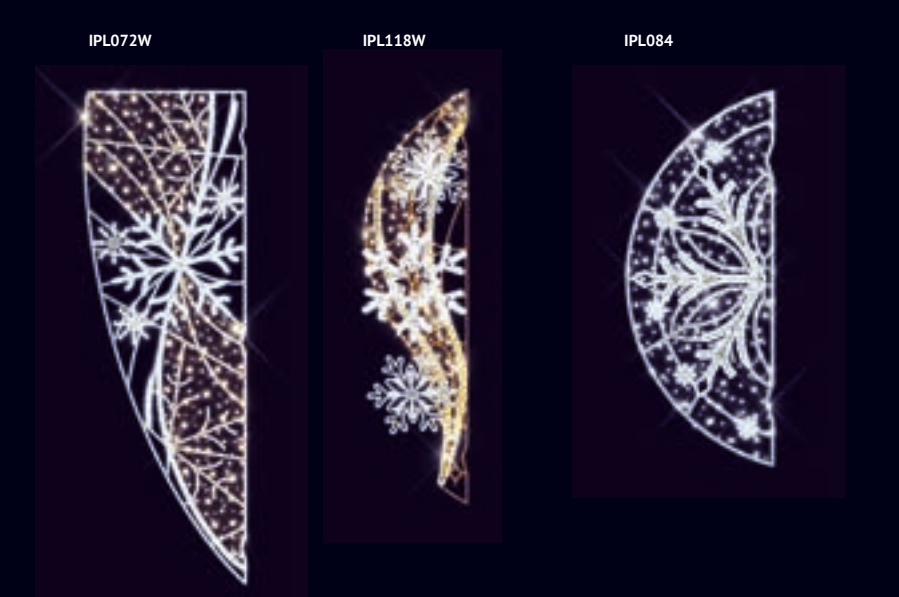

<p>IPL072W-ALYZE</p> <p>◆ 5.0m ◆ 1.0m ▣ 12.4kg ⚡ 60W</p> <p>● STARS&XLED&SLOWFLASH 102</p>	<p>IPL118W-BLIZZARD</p> <p>◆ 2.3m ◆ 0.7m ▣ 10kg ⚡ 60W</p> <p>● SLOWFLASH&STARS 100</p>	<p>IPL084-CRISTALLIN</p> <p>◆ 1.5m ◆ 0.6m ▣ 4.3kg ⚡ 35W</p> <p>● XLED&SLOWFLASH 35</p>	<p>ITL072W-ALYZE DOUBLE</p> <p>◆ 1.0m ◆ 6.0m ▣ 24.5kg ⚡ 120W</p> <p>● STARS&XLED&SLOWFLASH 203</p>	<p>TGL139W-BELLA</p> <p>◆ 1.5m ◆ 1.5m ▣ 18.3kg ⚡ 120W</p> <p>● FLASH 1</p>
<p>PL250-TIVANO</p> <p>◆ 1.8m ◆ 0.9m ▣ 4.6kg ⚡ 24W</p> <p>● STARS&FLASH</p>	<p>PL250B-TIVANO</p> <p>◆ 1.8m ◆ 0.9m ▣ 4.6kg ⚡ 24W</p> <p>● STARS&FLASH</p>	<p>PIX05B-XMAS PIX</p> <p>◆ 0.9m ◆ 0.9m ▣ 2kg</p>	<p>ITL118W-GRAND BLIZZARD</p> <p>◆ 1.0m ◆ 5.0m ▣ 24kg ⚡ 135W</p> <p>● STARS&SLOWFLASH 224</p>	



ITL072W / IPL072W

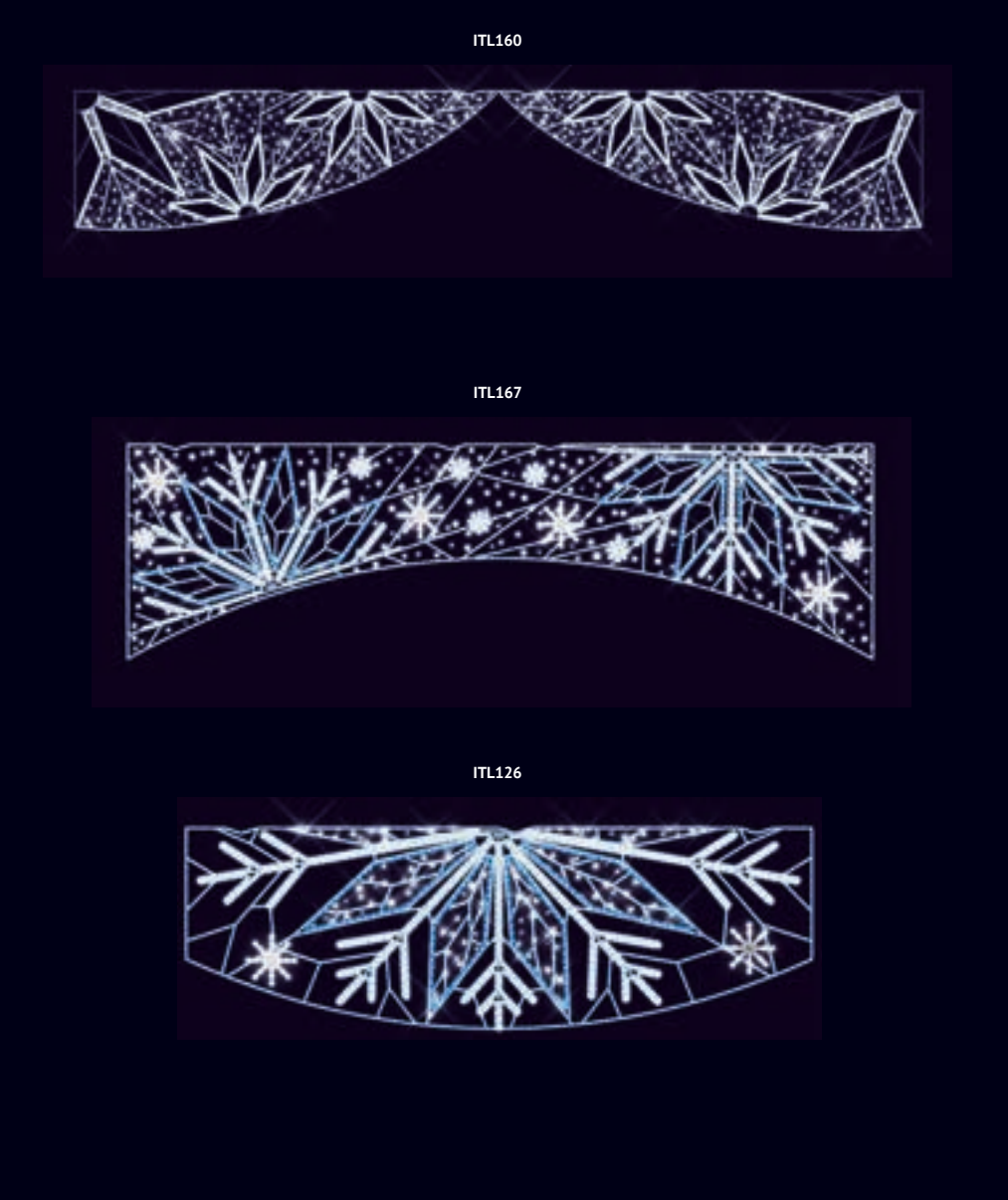
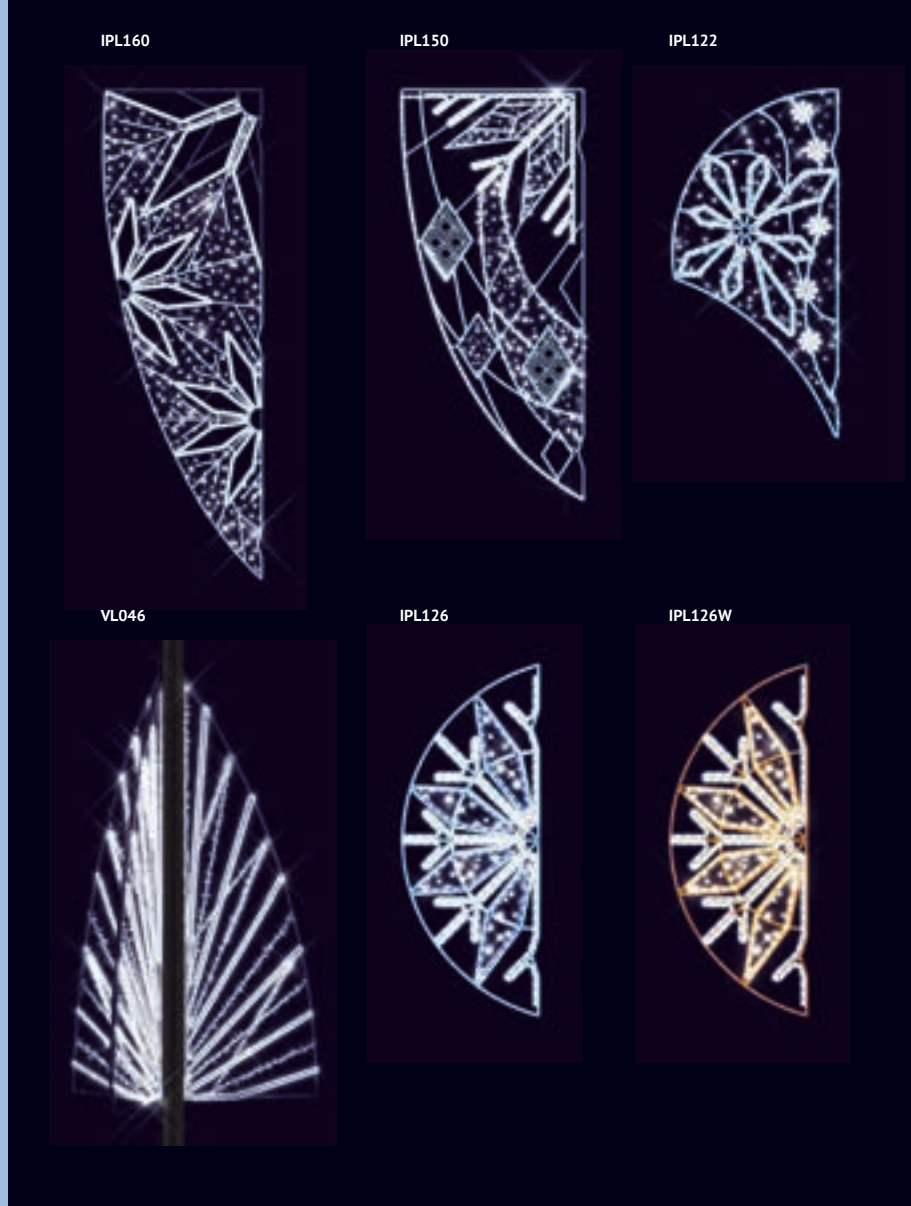

IPL160-VENTURO
 ◆3.0m ◆1.0m ◆ 11kg ◆ 65W
 FLASH 99

IPL150-THORN
 ◆2.0m ◆0.9m ◆ 6kg ◆ 40W
 XLED&FLASH 62

IPL122-ALTHAIR
 ◆1.5m ◆0.7m ◆ 4.2kg ◆ 30W
 STARS&SLOWFLASH 54

ITL160-VENTURO DOUBLE
 ◆1.0m ◆6.0m ◆ 22.6kg ◆ 130W
 FLASH 197

ITL126-ASIA CURVE
 ◆1.0m ◆3.0m ◆ 16.3kg ◆ 100W
 STARS&SLOWFLASH 201

VL046-LINE VL
 ◆3.0m ◆2.0m ◆2.0m ◆ 35.4kg ◆ 210W
 XLED&FLASH 235

IPL126-ASIA
 ◆1.5m ◆0.6m ◆ 5.4kg ◆ 40W
 SLOWFLASH 62

IPL126W-ASIA
 ◆1.5m ◆0.6m ◆ 5.4kg ◆ 40W
 SLOWFLASH 62

ITL167-APELIOTE
 ◆1.2m ◆4.0m ◆ 22.5kg ◆ 150W
 STARS 166

TO ORDER

stella

Whether shooting or sparkling, the star comes in every shape and shade to the delight of young and old, who come to admire this celestial show. The star is also the symbol of magic, and all your wishes come true with the wave of a wand!

STAR
MAGIC
CONSTELLATION
SUPERNOVA
LUMINARY
SOLAR

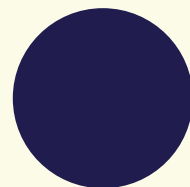
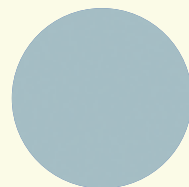
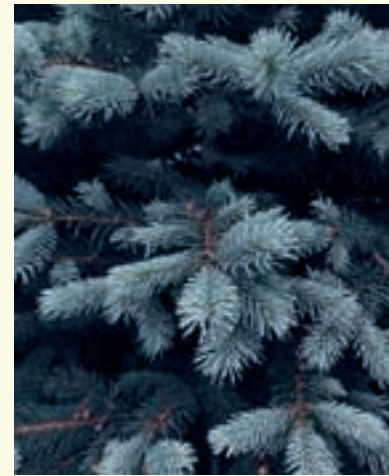

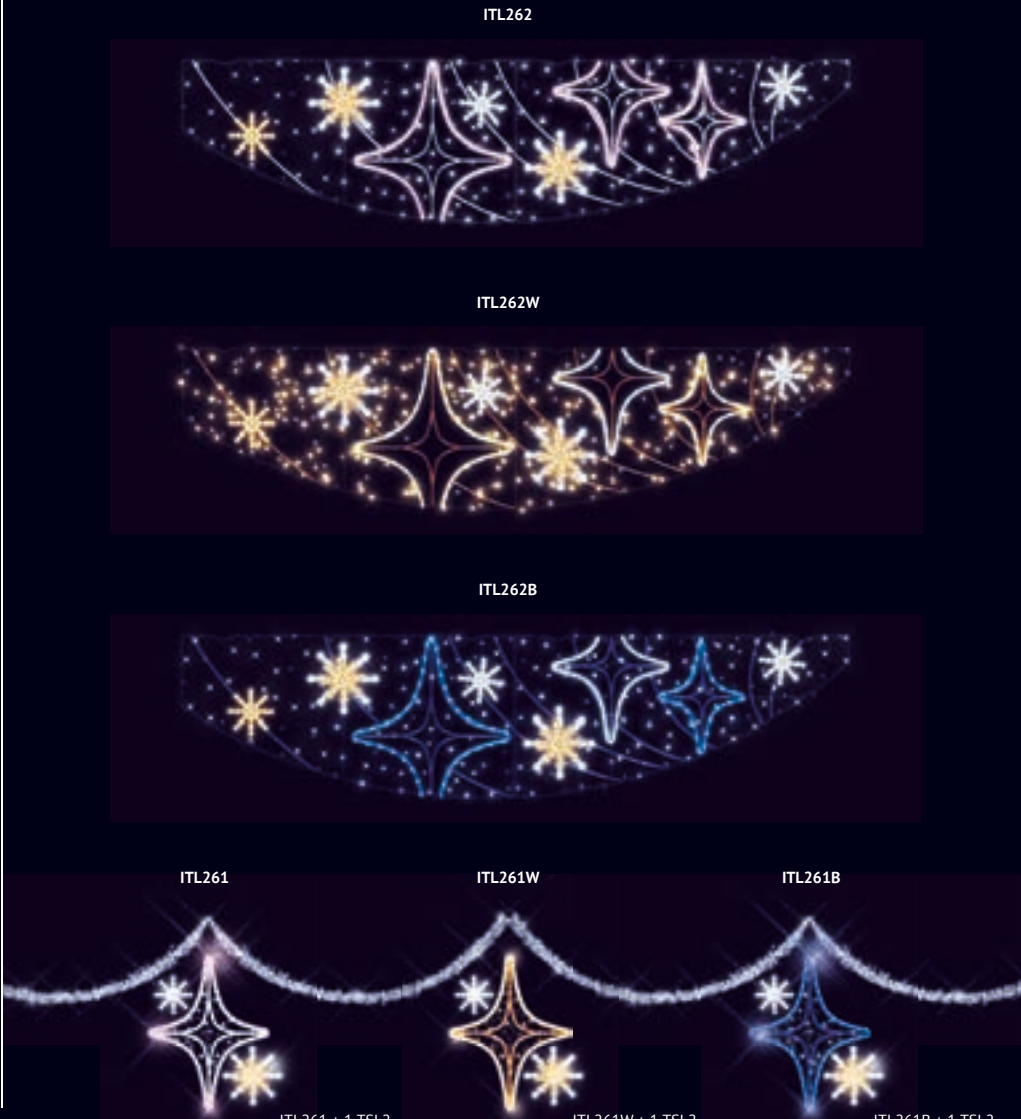
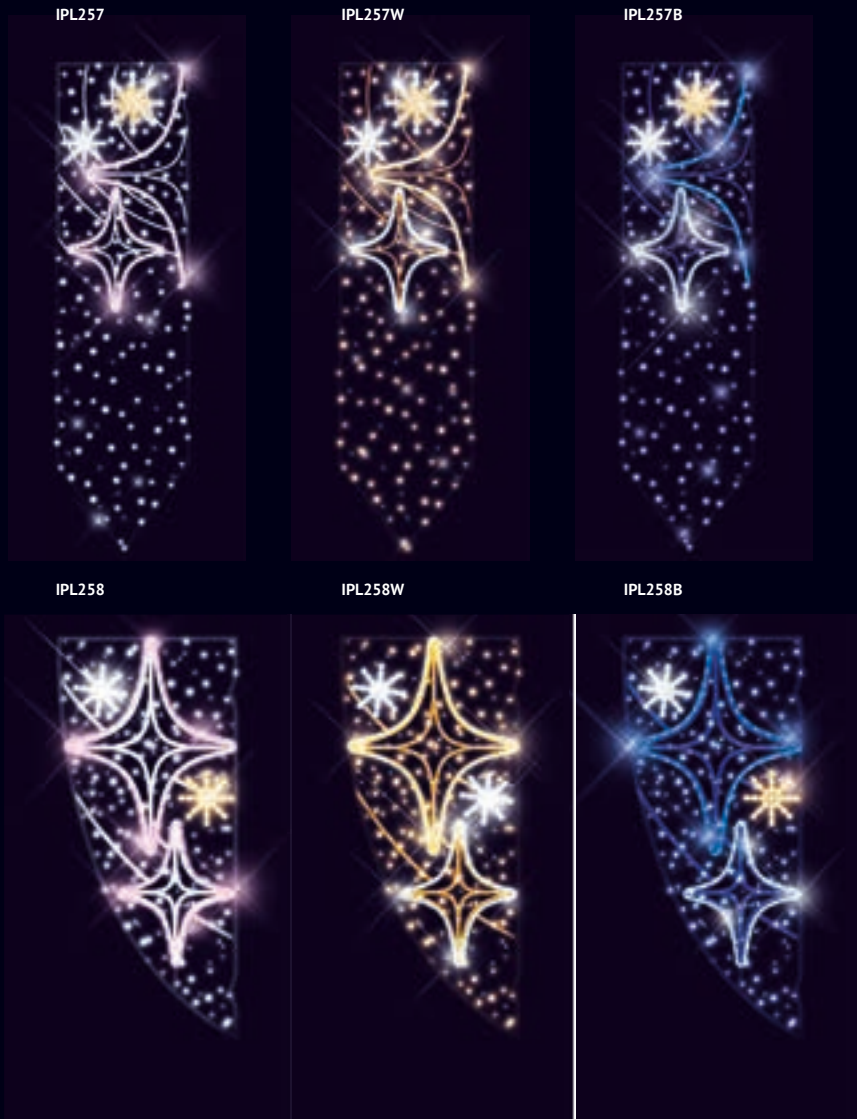

IPL257- ROMAN BANNER
 2.8m x 0.8m | 9kg | 30W
 SLOWFLASH&STARS 43
 TO ORDER

IPL257W- ROMAN BANNER
 2.8m x 0.8m | 9kg | 30W
 SLOWFLASH&STARS 43
 TO ORDER

IPL257B- ROMAN BANNER
 2.8m x 0.8m | 9kg | 30W
 SLOWFLASH&STARS 43
 TO ORDER

ITL262- ROMAN CURVE
 1.0m x 4.0m | 14.5kg | 65W
 SLOWFLASH&STARS 101
 TO ORDER

ITL262B- ROMAN CURVE
 1.0m x 4.0m | 14.5kg | 65W
 SLOWFLASH&STARS 101
 TO ORDER

ITL261W- ROMAN UNIT
 1.0m x 0.9m | 2.9kg | 20W
 SLOWFLASH&STARS 18
 TO ORDER

IPL258- ROMAN
 2.0m x 0.9m | 8kg | 30W
 SLOWFLASH&STARS 48
 TO ORDER

IPL258W- ROMAN
 2.0m x 0.9m | 8kg | 30W
 SLOWFLASH&STARS 48
 TO ORDER

IPL258B- ROMAN
 2.0m x 0.9m | 8kg | 30W
 SLOWFLASH&STARS 48
 TO ORDER

ITL262W- ROMAN CURVE
 1.0m x 4.0m | 14.5kg | 65W
 SLOWFLASH&STARS 101
 TO ORDER

ITL261- ROMAN UNIT
 1.0m x 0.9m | 2.9kg | 20W
 SLOWFLASH&STARS 18
 TO ORDER

ITL261B- ROMAN UNIT
 1.0m x 0.9m | 2.9kg | 20W
 SLOWFLASH&STARS 18
 TO ORDER



ITL261W / IPL258W



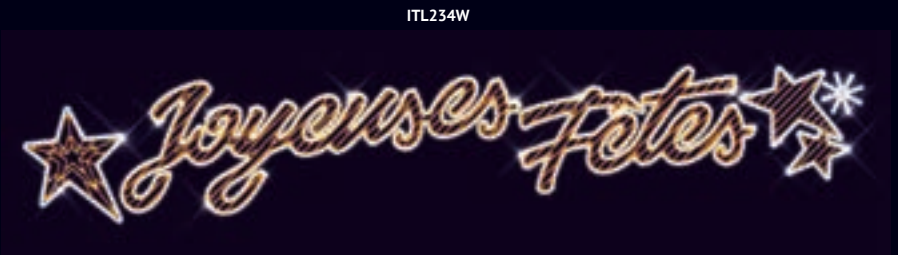
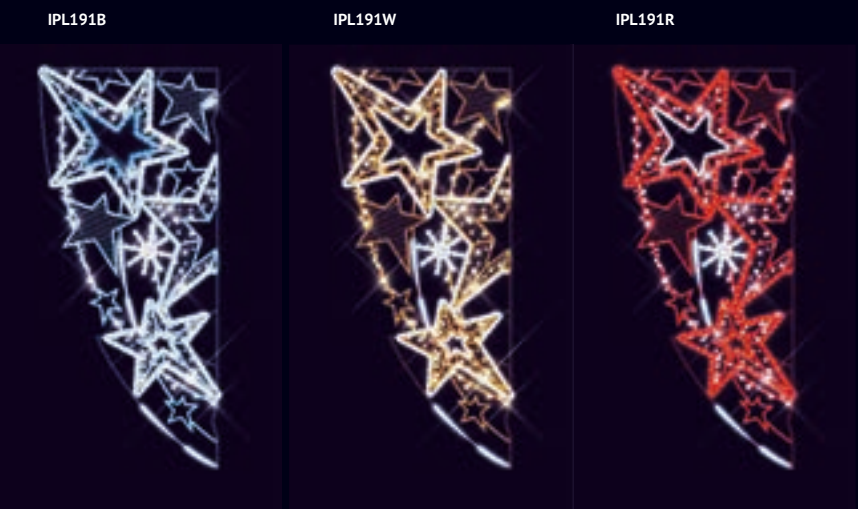

IPL259-ROMAN PETIT

1.2m 0.6m 2.7kg 15W
SLOWFLASH&STARS&XLED 24

IPL259W-ROMAN PETIT

1.2m 0.6m 2.7kg 15W
SLOWFLASH&STARS&XLED 24

IPL260W-ROMAN ROLL

1.3m 1.0m 3.6kg 15W
SLOWFLASH&STARS 1

ITL234W-ASTRAL JF

0.9m 4.5m 16kg 100W
STARS 19

ITL227W-ASTRAL CHAIN

1.0m 4.0m 11.9kg 65W
STARS&FLASH 68

IPL191B-ASTRAL

2.0m 0.9m 4.3kg 60W
SLOWFLASH&XLED&STARS 79

IPL191W-ASTRAL

2.0m 0.9m 4.3kg 60W
SLOWFLASH&XLED&STARS 79

IPL191R-ASTRAL

2.0m 0.9m 4.3kg 60W
SLOWFLASH&XLED&STARS 79

ITL227B-ASTRAL CHAIN

1.0m 4.0m 15.5kg 65W
STARS&FLASH 68



IPL190B

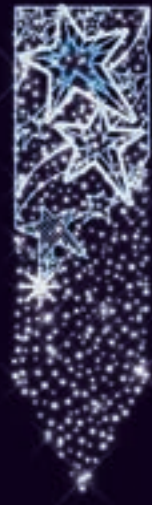

IPL190W



IPL190R



IPL189B



IPL189W



IPL189R



ITL094W



ITL191B



ITL191W



IPL190B-ASTRAL BANNER

2.8m x 0.8m | 10.1kg | 55W

XLED & STARS & SLOWFLASH | 67

TO ORDER

IPL190W-ASTRAL BANNER

2.8m x 0.8m | 10.1kg | 55W

FLASH & XLED & STARS | 67

TO ORDER

IPL190R-ASTRAL BANNER

2.8m x 0.8m | 10.1kg | 55W

FLASH & XLED & STARS | 67

TO ORDER

ITL094W-GRANDE STELLA

1.2m x 4.0m | 26.4kg | 195W

XLED & SLOWFLASH | 25

TO ORDER

ITL191W-ASTRAL TRAVERSE

0.9m x 4.0m | 20kg | 120W

STARS & XLED & SLOWFLASH | 167

TO ORDER

IPL189B-ASTRAL DRAPEAU

3.0m x 1.0m | 13.5kg | 65W

XLED & STARS & SLOWFLASH | 128

TO ORDER

IPL189W-ASTRAL DRAPEAU

3.0m x 1.0m | 13.5kg | 65W

XLED & STARS & SLOWFLASH | 128

TO ORDER

IPL189R-ASTRAL DRAPEAU

3.0m x 1.0m | 13.5kg | 65W

XLED & STARS & SLOWFLASH | 128

TO ORDER

ITL191B-ASTRAL TRAVERSE

0.9m x 4.0m | 20kg | 120W

STARS & XLED & SLOWFLASH | 167

TO ORDER



ITL091W



<p>IPL094W- STELLA</p> <p>◆ 3.0m ◆ 1.0m ◆ 10.8kg ↺ 70W</p> <p>■ XLED & SLOWFLASH 9</p>	<p>IPL228B- ASTRAL ROLL</p> <p>◆ 1.3m ◆ 1.1m ◆ 6kg ↺ 35W</p> <p>■ STARS & XLED & SLOWFLASH 51</p>	<p>IPL228W- ASTRAL ROLL</p> <p>◆ 1.3m ◆ 1.1m ◆ 6kg ↺ 35W</p> <p>■ STARS & XLED & SLOWFLASH 51</p>	<p>ITL082W- ANTHARES MM</p> <p>◆ 0.9m ◆ 0.9m ◆ 3.3kg ↺ 35W</p> <p>■ SLOWFLASH 37</p>	<p>ITL043W- CAJUN JF</p> <p>◆ 1.6m ◆ 4.6m ◆ 28.2kg ↺ 270W</p> <p>■ FLASH 175</p> <p>TO ORDER</p>
<p>IPL042W- CELESTE</p> <p>◆ 3.0m ◆ 0.9m ◆ 10kg ↺ 75W</p> <p>■ FLASH 92</p>	<p>IPL340W- ALPS</p> <p>◆ 2.3m ◆ 1.0m ◆ 9kg ↺ 70W</p> <p>■ FLASH 65</p>	<p>IPL117W- BLIZZARD BANNER</p> <p>◆ 2.8m ◆ 0.8m ◆ 10.2kg ↺ 45W</p> <p>■ SLOWFLASH 76</p>	<p>ITL083W- ANTHARES GM</p> <p>◆ 1.2m ◆ 1.2m ◆ 5.6kg ↺ 50W</p> <p>■ SLOWFLASH 47</p>	<p>ITL132W- BOLERO ARC</p> <p>◆ 1.2m ◆ 4.0m ◆ 19.5kg ↺ 135W</p> <p>■ XLED & SLOWFLASH 162</p>



PIX05B



IPL340W



IPL042W

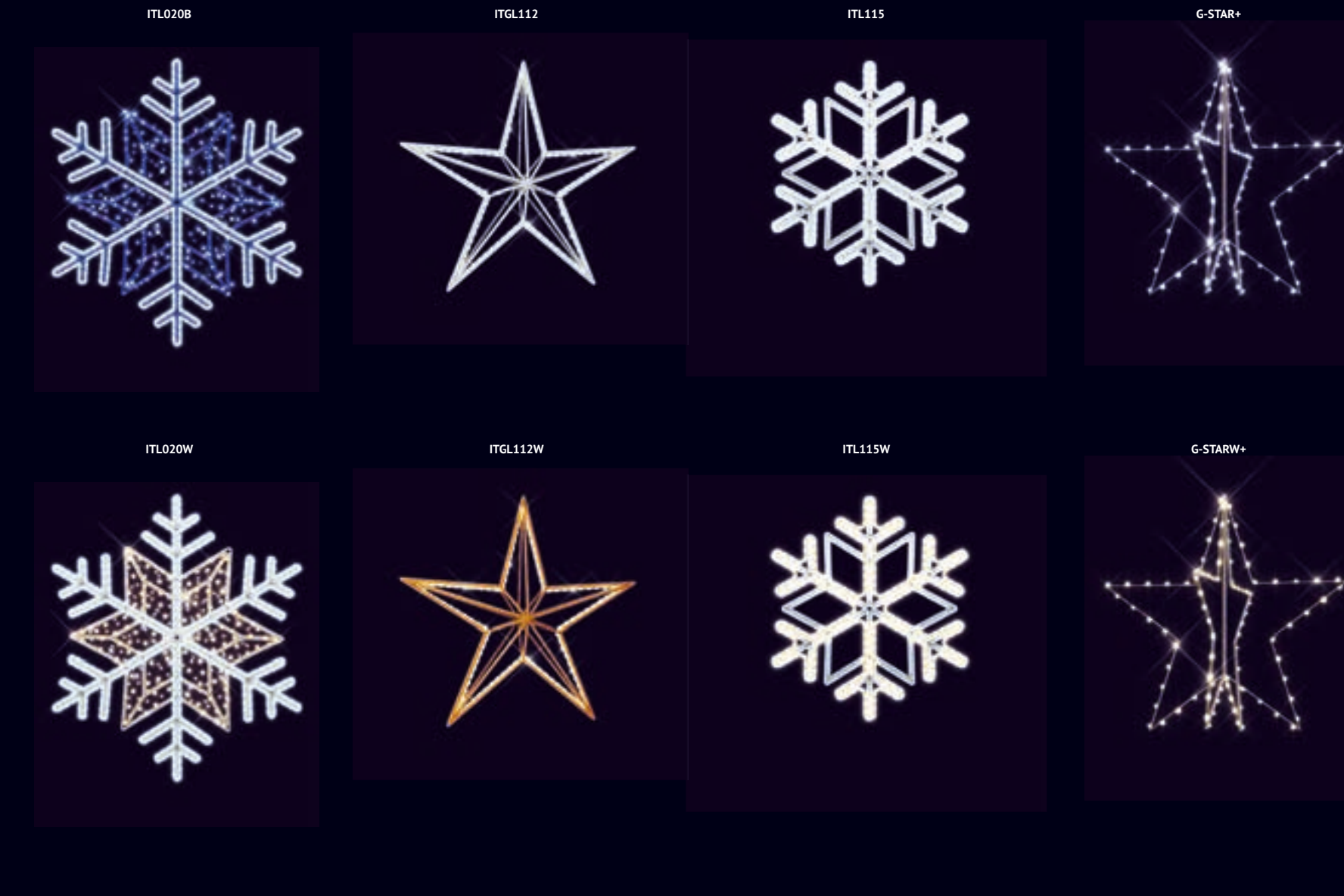

ITL020B-GIVRE

◆ 1.0m ◆ 0.9m ▣ 4.5kg ⚡ 40W
 ■ SLOWFLASH 47

ITGL112-STAR 5

◆ 0.8m ◆ 0.8m ▣ 1.5kg ⚡ 10W
 ●

ITL115-LILLY

◆ 0.5m ◆ 0.4m ▣ 4kg ⚡ 16W
 ● 2

G-STAR+- STAR

◆ 0.6m ◆ 0.6m ▣ 2.3kg ⚡ 12W
 ●

ITL020W-GIVRE

◆ 1.0m ◆ 0.9m ▣ 4.5kg ⚡ 40W
 ■ FLASH 47

ITGL112W-STAR 5

◆ 0.8m ◆ 0.8m ▣ 1.5kg ⚡ 10W
 ■ ●

ITL115W-LILLY

◆ 0.5m ◆ 0.4m ▣ 4kg ⚡ 16W
 ● 2

G-STARW+- STAR

◆ 0.6m ◆ 0.6m ▣ 2.3kg ⚡ 12W
 ●

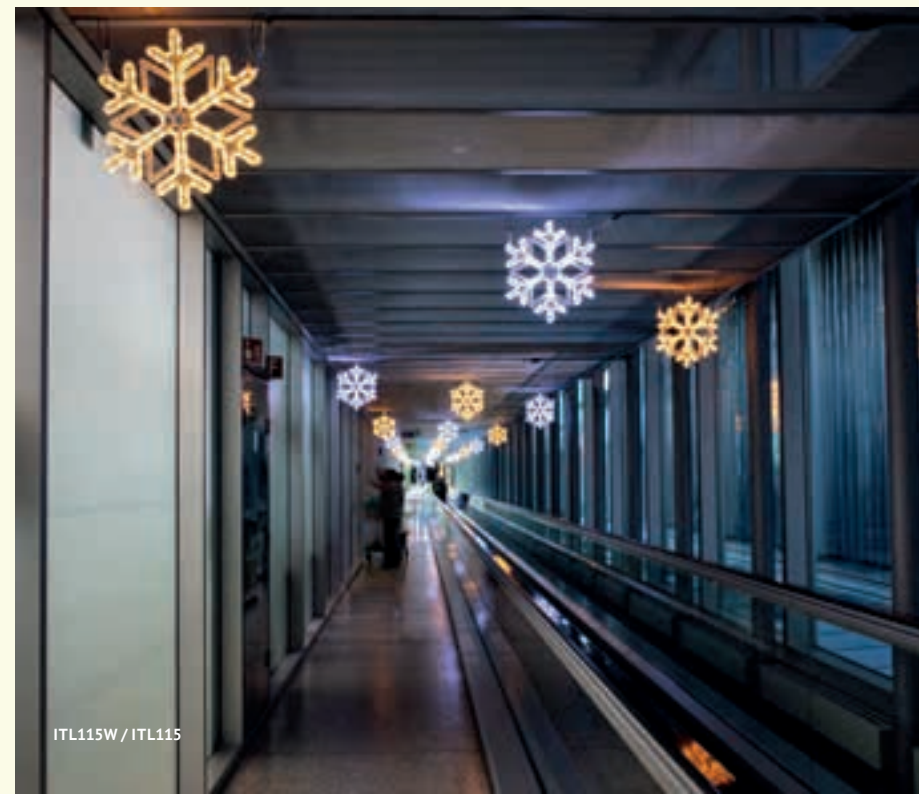

ITL115W / ITL115

ITL020W / ITL115W



DUO COLORS® RANGE

2 in 1 products!

FROM ONE YEAR TO THE NEXT, SWITCH YOUR DECOR FROM WARM WHITE TO PURE WHITE ACCORDING TO YOUR DESIRES!

You can choose from a warm white or pure white.
By reversing the connectors, you can obtain either a pure white decor/ pure white flash or a warm white decor/ warm white flash.

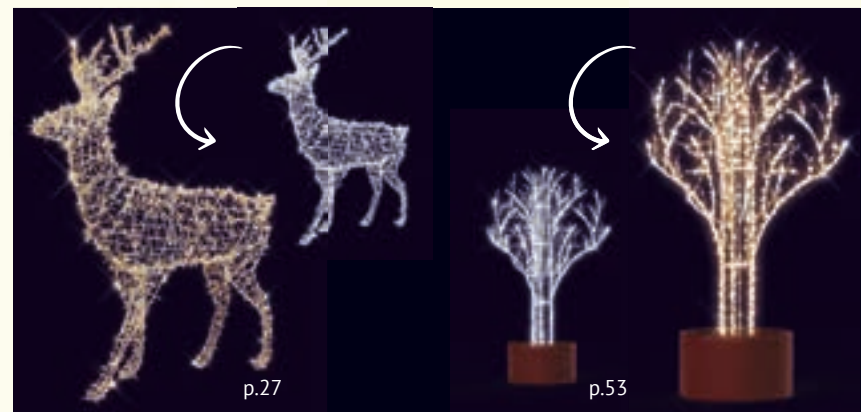
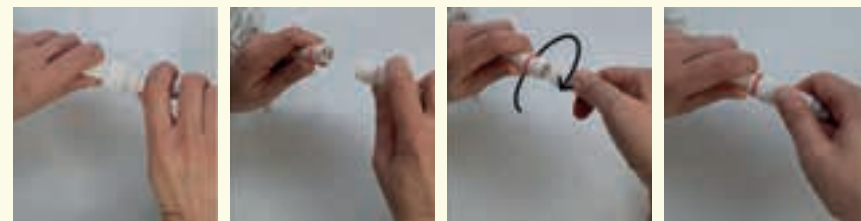

GX118DC- DUO COMETE
 ◆ 2.6m ◆ 2.2m ◆ 1.2m ◆ 27.4kg ◆ 35W
 ● FLASH

GX266DC- MINI MAGIC
 ◆ 2.5m ◆ 1.6m ◆ 1.6m ◆ 28.5kg ◆ 90W
 ● FLASH

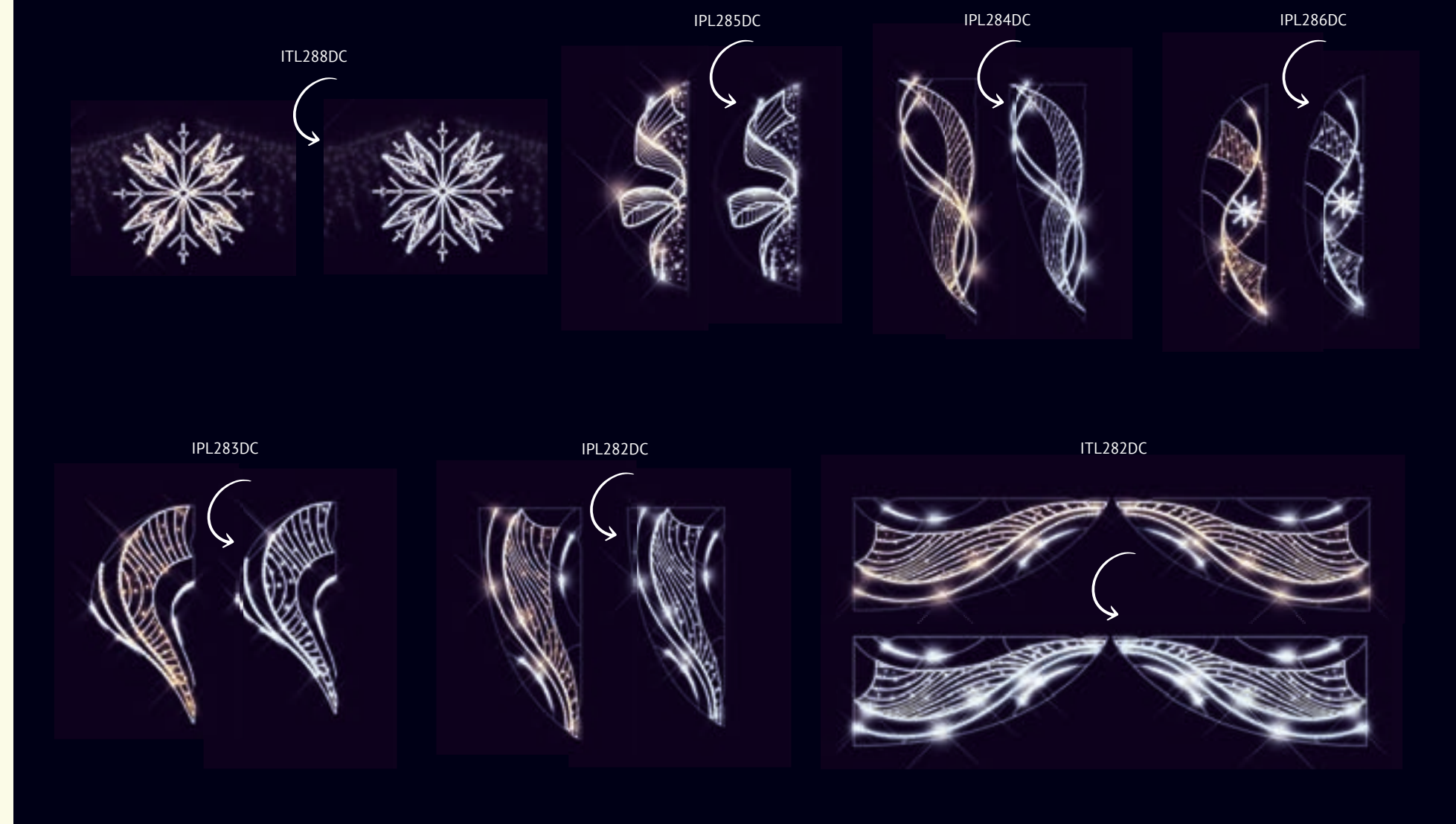

ITL288DC- DUO FLAKE
 ◆ 1.0m ◆ 1.0m ◆ ◆ 4.2kg ◆ 25W
 ● FLASH ◆ 65

IPL285DC- DUO PETIT
 ◆ 1.5m ◆ 0.6m ◆ ◆ 3.5kg ◆ 25W
 ● FLASH&XLED ◆ 38

IPL284DC- DUO GRANDE
 ◆ 3.0m ◆ 1.0m ◆ ◆ 9kg ◆ 35W
 ● FLASH ◆ 13

IPL286DC- DUO
 ◆ 2.1m ◆ 0.5m ◆ ◆ 4.2kg ◆ 15W
 ● FLASH&STARS ◆ 37

IPL283DC- DUO LINE
 ◆ 1.5m ◆ 0.7m ◆ ◆ 4kg ◆ 20W
 ● FLASH&XLED ◆ 58

ITL282DC- DUO DOUBLE
 ◆ 0.9m ◆ 4.0m ◆ ◆ 12.6kg ◆ 50W
 ● XLED&FLASH ◆ 140

IPL282DC- DUO LINE GRAND
 ◆ 2.0m ◆ 0.9m ◆ ◆ 6.2kg ◆ 25W
 ● FLASH&XLED ◆ 17



SOLAR RANGE

Varied decorations that adapt to all your decoration themes and work with solar energy

**Consumption:
Zero watts !
Zero € !**

Thanks to our new solar-powered rechargeable battery, you can combine lighting with energy efficiency.

Once your decor is in place, position the solar box on top of it facing the right way, set your switch-on and switch-off times and enjoy your lighted decorations.
Technical details:

- 8 to 10 hours of recharging with optimal sunlight for 7 hours of lighting.
- Your lights can be programmed to operate for 5, 6 or 7 hours.

Enter decor reference no. + PIXSOL2

PIXSOL2

20W panel power
7,2W power output

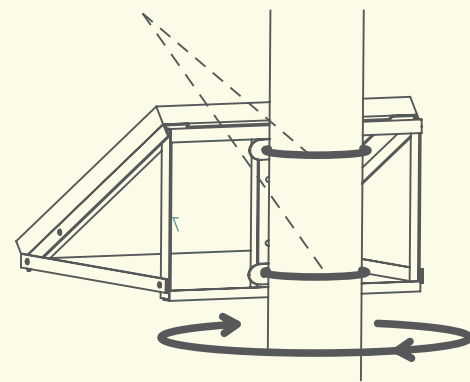

When you set it up, make sure it is facing the right way to get the most sun during the day
These decorations are equipped only with 24V LED garlands.

100%
autonomous



PIXSOL2 (p.275)

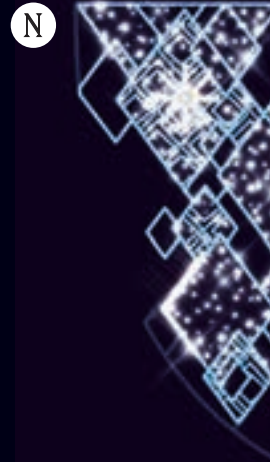

IPS289W- STARS S.
◆ 1.2m ◆ 0.60m ◆ 4.0kg ⚡ 8W
● FLASH&STARS 30
TO ORDER

IPS290- RIBBON S.
◆ 1.8m ◆ 0.45m ◆ 5.0kg ⚡ 10W
● FLASH&XLED 38
TO ORDER

IPS280W- QUADRILLE S.
◆ 2.0m ◆ 0.9m ◆ 7.0kg ⚡ 11W
● FLASH&XLED&STARS 57
TO ORDER

IPS264W- BLIZZY S.
◆ 1.2m ◆ 0.5m ◆ 3.0kg ⚡ 4W
● FLASH&STARS 28
TO ORDER

IPS280- QUADRILLE S.
◆ 2.0m ◆ 0.9m ◆ 7.0kg ⚡ 11W
● FLASH&XLED&STARS 57
TO ORDER

IPS281W- RIBBON S.
◆ 1.2m ◆ 0.6m ◆ 4.0kg ⚡ 7W
● XLED&STARS 28
TO ORDER

PLAY MAGIC

Play in augmented reality!

Allowing audiences to do things like take a photo with Father Christmas or play with Charlie the Unicorn, our augmented reality apps add virtual characters into the real world, leaving the public laughing and amazed. Children and adults can easily take part in the fun using a smartphone enjoying an unforgettable experience that transforms reality into a unique performance.

How does it work?

For the public, the idea is simple: When users approach the Play Magic banner, the app they have pre-installed on their phone automatically unlocks to give them access to the games.

They can then share the experience on their social media pages. The public app features your branding and a link to your website or social media.

For the city:

The games app has a subscription model valid while the illuminations are up, with games updated each year.

Apart from this, all you need to do is install the banner near the illuminations to tell the public they can enjoy a free game on their phone in the location. There is no need for any connection. The app's success also depends on you advertising it on displays in your town/city and on your social media pages.

We can assist you in setting up your communications (Réf. ARCOM below).

Reference	Description
AR001	3 games pack (chosen from the 7 existing games) + 1 Totem
AR002	5 games pack (chosen from the 7 existing games) + 1 Totem
ARTOT02	1 additional Totem
ARCOM	Augmented Reality Communications Pack (non-printed poster, web banner and smartphone-format image).

Games available:



FR : AR001
EN : AR001-EN
ES : AR001-ES



GX103L-BILLY
◀ 2.7m ▶ 2.9m ▮ 1.4m ⚖ 65.5kg ⚡ 81W
🎨 XLED 📺 134
TO ORDER

GX103L-A-BILLY ANIME
◀ 2.7m ▶ 2.9m ▮ 1.4m ⚖ 78.5kg ⚡ 121W
🎨 INTERACTIVITE&XLED 📺 134
With push buttons
TO ORDER

GX146L-MARLEY
◀ 2.3m ▶ 2.6m ▮ 0.7m ⚖ 46.5kg ⚡ 20W
🔵 FLASH

GX200L-LULU
◀ 1.6m ▶ 1.4m ▮ 0.7m ⚖ 20.5kg ⚡ 15W
🔵 FLASH

EXCLUSIVE POSTCARD CONCEPT

Discover our customizable postcards featuring the name and symbols of your city!

Our postcards, crafted with 3D printing and eco-friendly materials, are more than just cards: they're customizable to include the name of your city, town, or region, along with iconic symbols of your local culture and heritage.

Imagine a piece of art that proudly reflects your geographic identity while adding a personal and modern touch to your space.

Contact your account manager to design your unique postcard together.

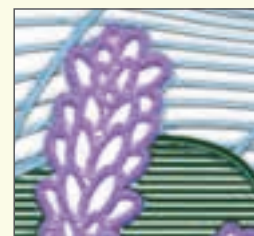

ECO-FRIENDLY MATERIALS



MOUNTED ON A FRAME FOR ADDED STABILITY



CUSTOMIZABLE & MADE-TO-MEASURE





BI-SEASON ARCH & TREE

Discover our dual-season urban furniture that adapts with the changing seasons!

First of all select your base:

A bright arch composed of pure white LEDs, livened up with wooden benches

A shade tree endowed with pure white LED spots and a white wooden bench base equipped with USB plugs.

Then, for a colourful summer look, add the SUMMER passive decoration kit to this base.

For a frosted look for year-end celebrations, add the WINTER bright decoration kit.



HIGH-QUALITY WOOD BENCH



USB PORT



SPOTLIGHT



BASE	◆	◀	▣	👤	●
	3.0m	3.2m	3.2m	127kg	GX242L

KIT	◆	◀	▣	👤	○
	27.0m			56.7kg	KIT1-242



BASE	◆	◀	▣	👤	●
	3.0m	3.2m	3.2m	127kg	GX242L

KIT SUMMER	◆	◀	▣	👤	○
	32.0m			38kg	KIT2-242



BASE ARCH	◆	◀	▣	👤	●
	3.5m	5.0m	3.6m	245.3kg	SL134

KIT ARCH	◆	◀	▣	👤	○
	39.0m			41kg	KIT1-134



BASE ARCH	◆	◀	▣	👤	●
	3.5m	5.0m	3.6m	245.3kg	SL134

KIT ARCH SUMMER	◆	◀	▣	👤	○
	37.0m			21.7kg	KIT2-134



PALM	◆	◀	▣	👤	■
	3.6m	3.2m	3.2m	160kg	GX243LW

2D & 3D LETTER

Stand Out! Showcase your identity with our XXL Lettering

Place them wherever you like—on roundabouts, in front of your town hall, or near any iconic landmark in your community.

We offer various options for volume, size, color, and weighted base:

Our 2D letters come in Recyprint gold and white, made from recycled plastic bottles and fully recyclable. They are available in heights of 1.4m or 2m. The lightweight, discreet aluminum frame is crafted from recycled material and designed to hold your weighted base.

This year, we're introducing 3D letters with added depth. Covered in Flexiprint—our new flexible, recyclable material made from recycled plastic—these letters feature white front and back faces with gold-colored edges.

Two sizes are available:

- 1.8m with a depth of 60cm
- 1.4m with a depth of 40cm

These 3D letters also come with a black lacquered base that serves as a weighted support, offering a turnkey, ready-to-install lettering solution.

All our lettering includes warm white spotlights, so your name will shine at nightfall.



ECO-FRIENDLY MATERIALS



DISCREET BLACK LACQUERED FRAME



SPOTLIGHT



2D LETTER - WHITE

TO ORDER



2D LETTERS BLANC	◆	◀	▶	⚙️	📏	⚖️	🎨
	1.4m				15.5kg	LETTREPMB	

2D LETTERS XL-BLANC	◆	◀	▶	⚙️	📏	⚖️	🎨
	2.0m				18.5kg	LETTREGMB	

2D LETTER - GOLD

TO ORDER



2D LETTERS OR	◆	◀	▶	⚙️	📏	⚖️	🎨
	1.4m				15.5kg	LETTREPMO	

2D LETTERS XL-OR	◆	◀	▶	⚙️	📏	⚖️	🎨
	2.0m				18.5kg	LETTREGMO	

3D LETTER WITHOUT BASE PLATE

TO ORDER



3D LETTERS	◆	◀	▶	⚙️	📏	⚖️	🎨	N
	1.4m	1.5m	0.4m		15kg	LET3DPM		

3D LETTERS XL	◆	◀	▶	⚙️	📏	⚖️	🎨	N
	1.8m	1.9m	0.6m		25kg	LET3DGM		

3D LETTER WITH BASE PLATE

TO ORDER



3D LETTERS-BASE	◆	◀	▶	⚙️	📏	⚖️	🎨	N
	1.4m	1.5m	0.4m		97kg	LET3DPM-P		

3D LETTERS XL-BASE	◆	◀	▶	⚙️	📏	⚖️	🎨	N
	1.8m	1.9m	0.6m		119kg	LET3DGM-P		



DRESSING CITY BARRIERS & PLANTERS

2D ground decor

Adorn your urban furniture with colourful environmentally-friendly decorations!

Marine, floral or butterfly theme – customise the decoration of your town barriers or planters. You can choose the background colour of the decoration as well as the motif which will be applied on top, everything will be tailor-made in Bioprint, our biodegradable, recyclable material.

Customised project, contact us.



TREE CORSET

3D ground decor

Embellish your tree trunks!

Our tree corsets will adorn and light up your trees while protecting them and ensuring optimal hold. Available in bright or passive versions and in a wide array of colours, there are unlimited combinations to liven up your urban areas or green spaces with style and creativity.

Customised project, contact us.





FUNNY ANIMAL CONTAINERS

Our funny animals join you on your recycling journey!

Educating young people about recycling is a major challenge, and we have met it with creativity and humor.

We have transformed this vital initiative into a fun and joyful collective act with animal-shaped recycling containers. Placed in city centers or along beaches, whales, fish, and turtles house recycling bins.

The collected plastic bottles are retrieved by specialized organizations, from which we source the raw material. This is then fed into our printers to produce structures made from Recyprint, our material crafted from PET (polyethylene terephthalate) sourced from the food industry.



COMPATIBLE LARGE-FORMAT CONTAINER



DOOR INTEGRATED INTO THE DESIGN



COMMUNICATION ON THE PRINCIPLE OF COLLECTION



SIMON	◆	◀	▶	■	👤	■
	2.1m	1.5m	3.3m	54.5kg	GX110	

TO ORDER

SIMON	◆	◀	▶	■	👤	■
	2.1m	1.5m	3.3m	54.5kg	GX110-UK	

TO ORDER



BULLE	◆	◀	▶	■	👤	■
	2.3m	2.1m	3.7m	86kg	GX107	

TO ORDER

BULLE	◆	◀	▶	■	👤	■
	2.3m	2.1m	3.7m	86kg	GX107-UK	

TO ORDER



GAIA	◆	◀	▶	■	👤	■
	2.3m	2.1m	4.0m	82kg	GX108	

TO ORDER

GAIA	◆	◀	▶	■	👤	■
	2.3m	2.1m	4.0m	82kg	GX108-UK	

TO ORDER





RANGE

Garlands and light decorations

- MULTICOLOURED RGBWW/RGB RANGE 162–167
- LED GARLANDS 168–185
- LED CURTAINS 186–203
- LED STALACTITES 204–213
- CEILINGS AND BRAIDS 214–227
- SUSPENSIONS AND DECORATIONS 228–247
- PROJECTORS 248–253
- CONTROL SYSTEM 254–259
- TECHNICAL PAGES 260–288

CONTENTS



LEGENDS

- ◆ Height
- ◆ Length
- ▣ Depth
- ⚡ Voltage
- Cable colour
- ☀ Flash colour
- LED Colour
- N New
- ▤ Number of runs
- 🔌 Number of connectable garlands
- 🏠 Indoor/outdoor use
- 📏 Type of cable
- 🛡 Protection class
- 🔌 Power cord supplied
- 🔨 Impact rating
- 🤖 Exclusive 230V octoplus by blachere© range
- 🤖 Exclusive 24V octoplus by blachere© range
- 🤖 Exclusive 12V octoplus by blachere© range

led+

An exclusive 100% Blachere® innovation

Taking a practical approach to innovation, our R&D department has developed the all-new Led+ in fixed and slowflash versions to give your projects a real boost! The result of a collaboration with Nichia®, the world leader in LEDs, we now offer you an exclusive new Led range.

+ bright, + robust, + long life, + uniform colour

The new technical characteristics of Led+ are:

- > **Design optimised and registered** to promote the lighting efficacy of our solutions (inverted cone principle).
- > **Maximised heat dissipation** for longer LED life.
- > **Uniform phosphor deposition** for uniform light output.
- > **2-year guarantee**
- > **Optimum protection rating: IP66/IP69**
- > **230V Octoplus by Blachere IP67 connectors**

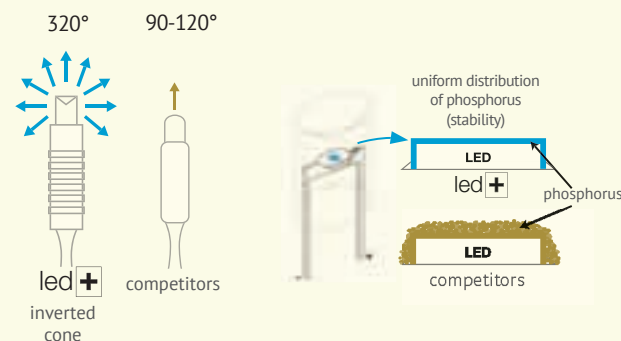

LED+ RANGE: MORE EFFICIENT, LESS ENERGY-CONSUMING

Blachere is committed to tackling environmental and energy issues: In 2024, we will be lowering the power consumption of our LED+ range in order to reconcile illuminations with energy efficiency

As a result of extensive work on the energy performance of our LEDs, **we have reduced the wattage of our LED+ range by an average of 15%**, while maintaining its brightness and lifespan (the wattage of each product has been updated in our technical specification tables).

As a result, our products **consume less energy while maintaining the same high light density.**

The different types of Blachere® LEDs.

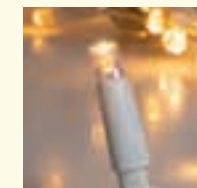

LED + :
See box on the left

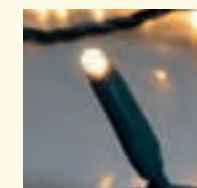

LED Classique :
A robust and stable encapsulated LED with an inverted interior cone.

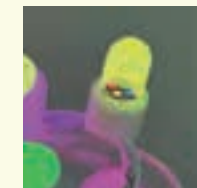

LED RGBWW/RGB :
A special capsule for better color diffusion.

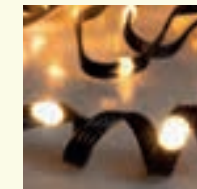

Micro LED :
A LED delicately placed on a micro cable, creating a fine and refined effect.



LED SMD :
The ultimate electrical component, manufactured by an automatic machine.

GARLAND iLED ColorTech by Blachere®

RGBWW - multicoloured



RGBWW technology completely reinvented!

Over the last 2 years, we have developed a new RGBWW LED, **the brightest on the market, which can be controlled pixel by pixel** using a combination of software and "open command" animations (DMX compatible).

With incredible luminosity and a range of unique colours, our RGBWW garland opens up a host of possibilities for illuminated decorations (garland configuration or curtain configuration, for trees and facades).

This technology requires a personalised analysis tailored to your project

Ask for an analysis!

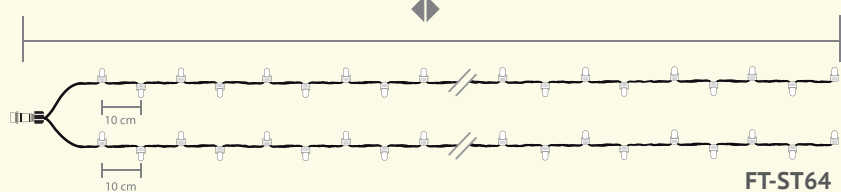
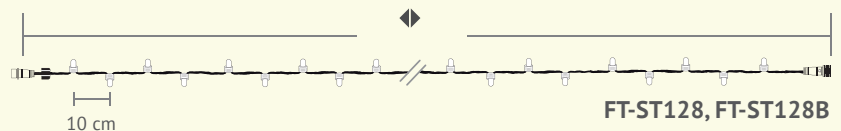
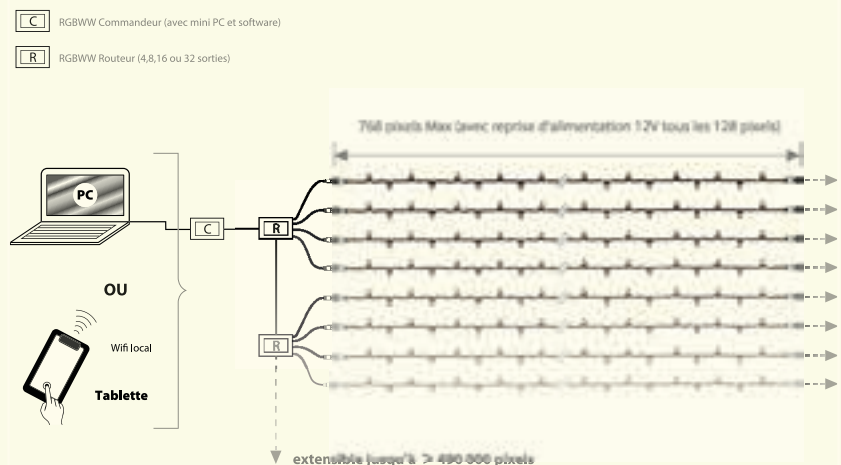
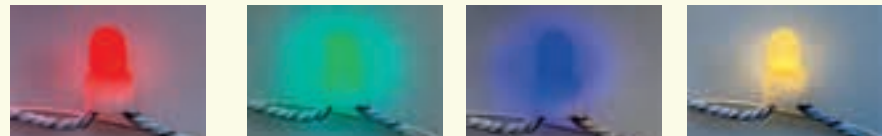

RGBWW GARLANDS

◄	LED	P (W)	■	□
13.0m		30	FT-ST128	
13.0m		30		FT-ST128B
2 x 6.5m		30	FT-ST64	



Brighter (WW 10 lumen per pixel)

New shape of LED

Up to 6 end-to-end garlands (768 linear pixels) > 490 000 pixels



Free pixel addressing

Open software (DMX compatible), professional and intelligent (multilingual)

Single colours / shades (2300/2500K warm white)

Reinforced (nylon cable)

GARLAND iLED ColorTech by Blachere®

RGBWW - multicoloured



Transform an avenue or a square into a unique, multicolored, and animated spectacle.

By equipping your trees with iLED ColorTech RGBWW, you become the conductor of this show, creating your own animations according to your preferences and schedule (hourly, daily, weekly, or even monthly, for example).



Create a multicolored and animated tent above a square or roundabout. An aerial installation that creates a magical starry sky, fully customizable to your preferences.



Transform your main avenue into a unique gathering place and energize your city center by creating a multicolored light show.

The endless animation possibilities will allow you to create a spectacle (for example, every half hour) and attract a crowd that loves light events! A great way to boost your local economy during the festive season...

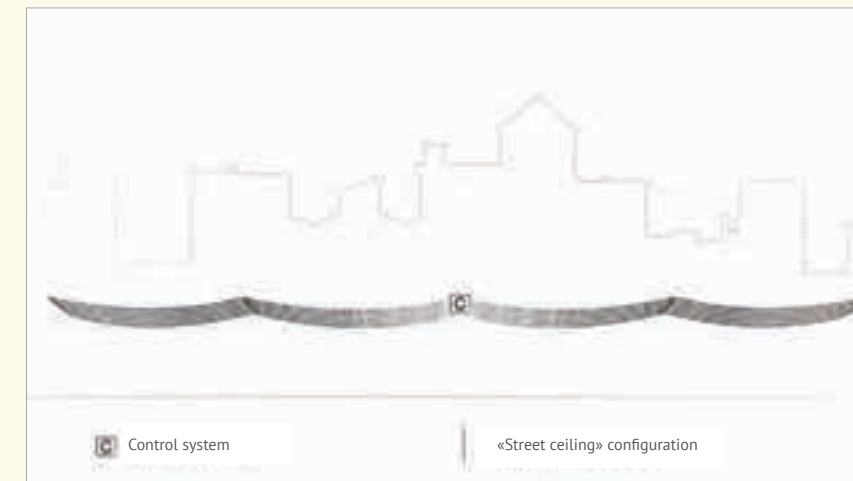

Why not create your own giant light screen on the façade of your town hall? Each evening, attract a crowd of spectators eager to enjoy the light show, specially designed for the occasion, to complement your Christmas market or city festivities!

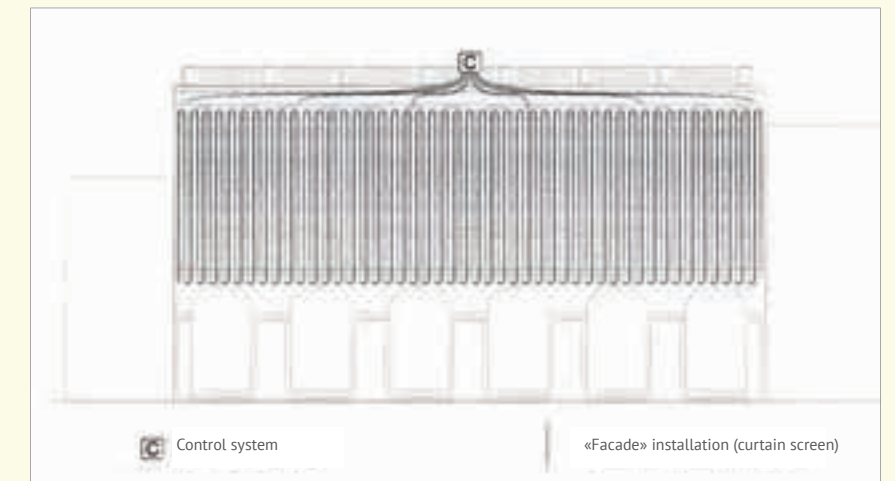

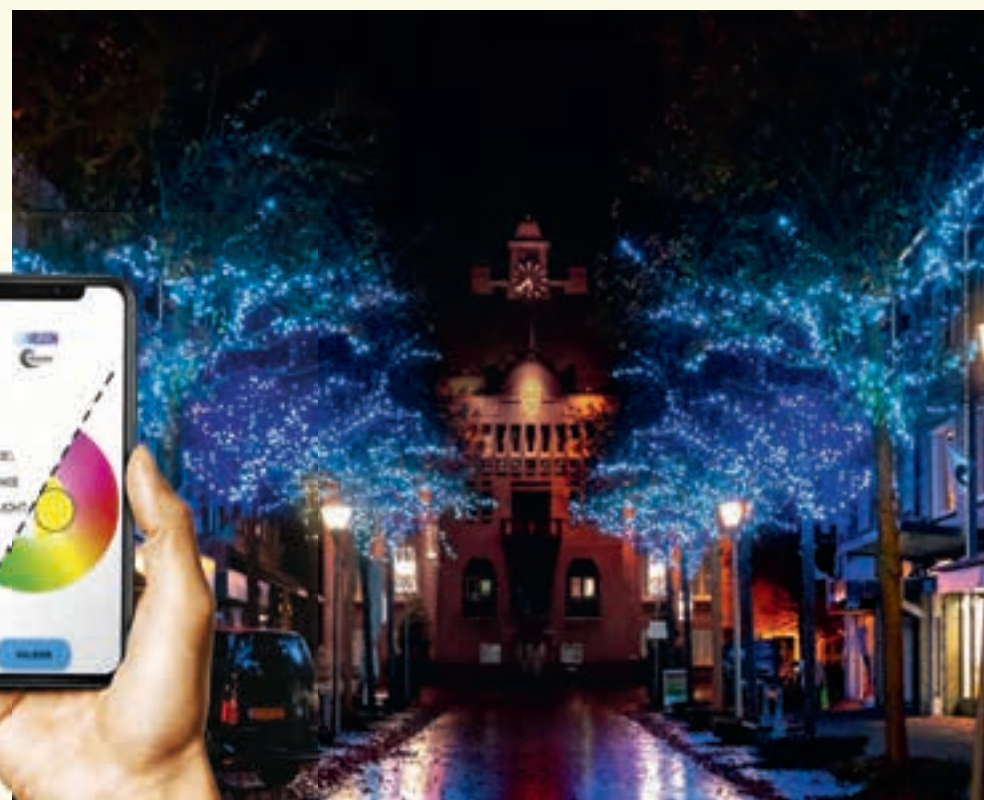

MULTICOLOURED RGB CONTROLLABLE GARLAND

colour changing

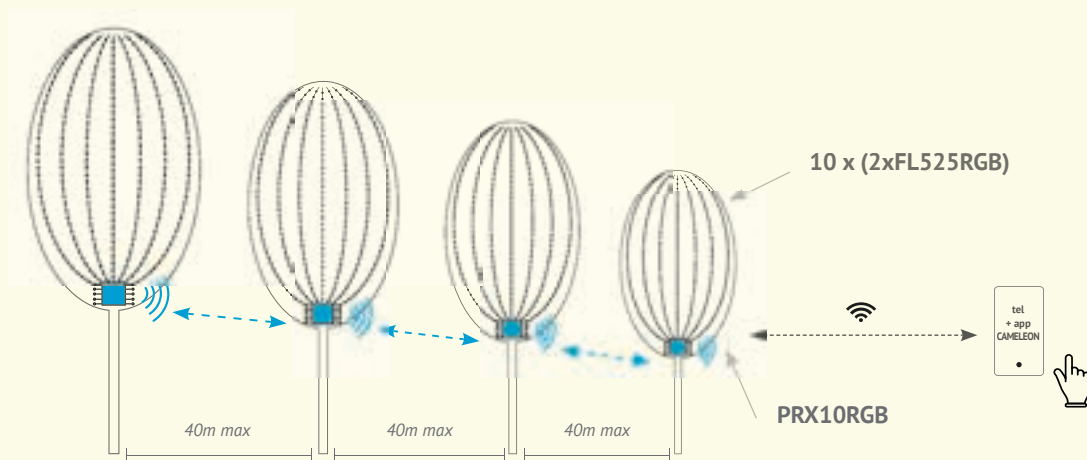
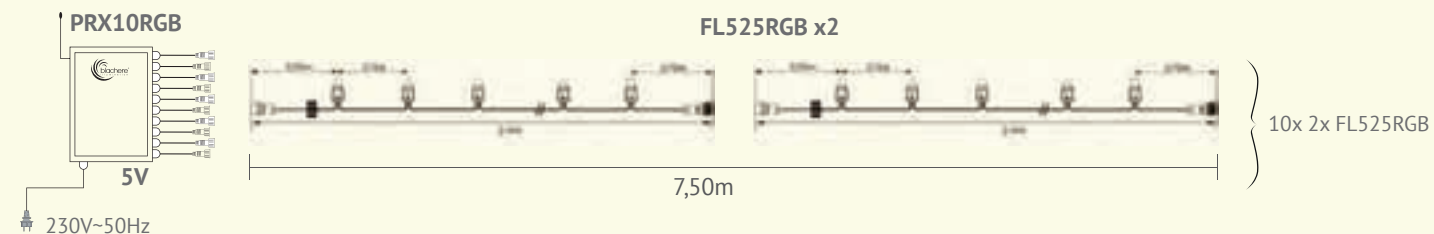

PRODUCT DETAILS

Customise the lighting, colour and animation of your trees, on a monthly, weekly or special event basis throughout the year.

For a tree of 8 to 10m:
 - 20 FL525RGB strands for 10 radians of 7.50m (2x3.75),
 - a PRX10RGB box
 - the Cameleon application on your smartphone.
 Maximum colour spectrum thanks to RGB LED technology.
 Communication via Bluetooth 5 between communications, Wi-Fi communication between phone + sets.

description	◀	LED	P (W)	📶	■
RGB - 5V	3,75 m	25 RGB	7,5	2	FL525RGB

Caméléon set	input voltage	output voltage	no. of pixels	P (W)	no. of outputs	Ref
	230V	5V	10 x 50 = 500	150	10	PRX10RGB

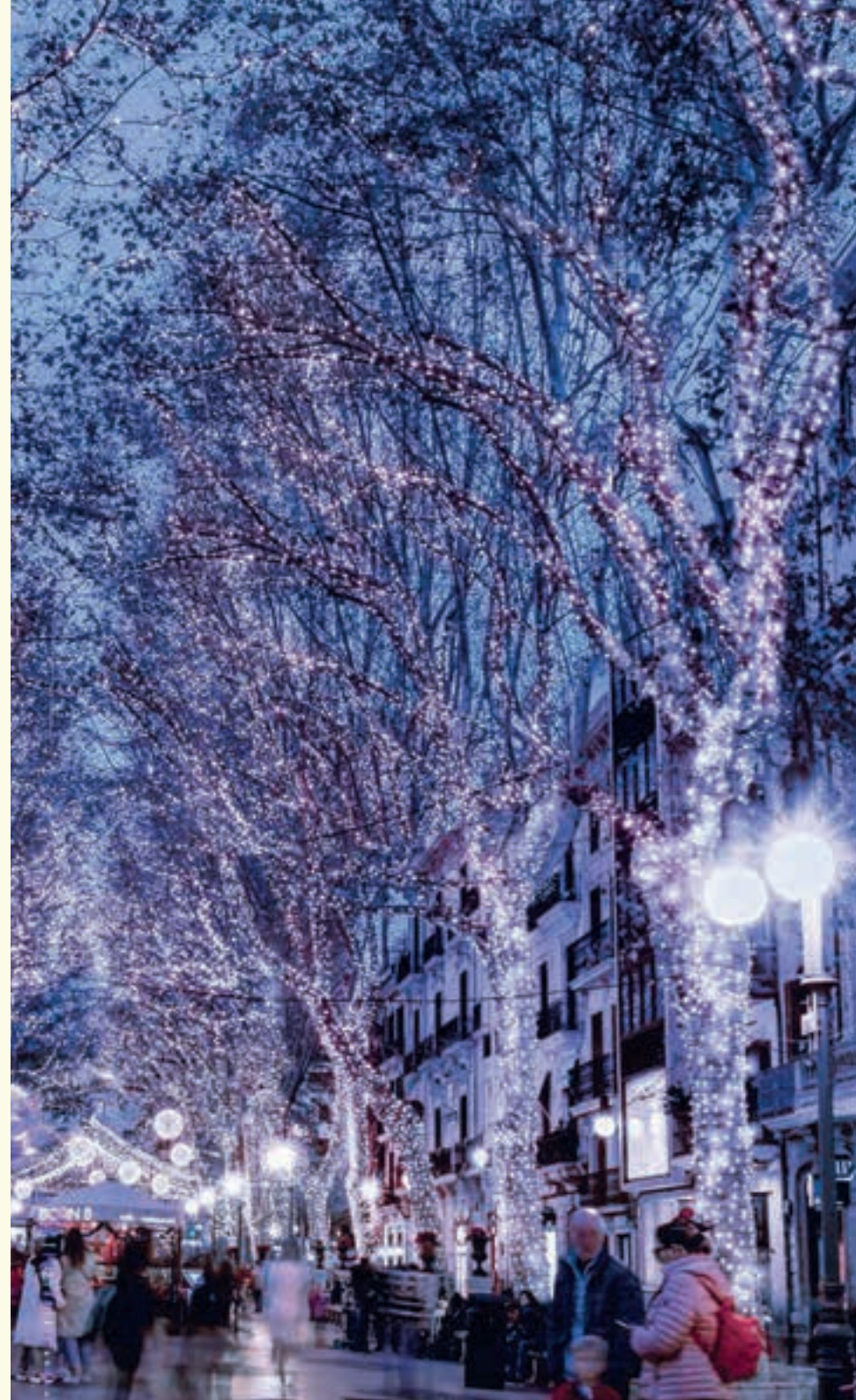

DUO COLORS® GARLAND

flash

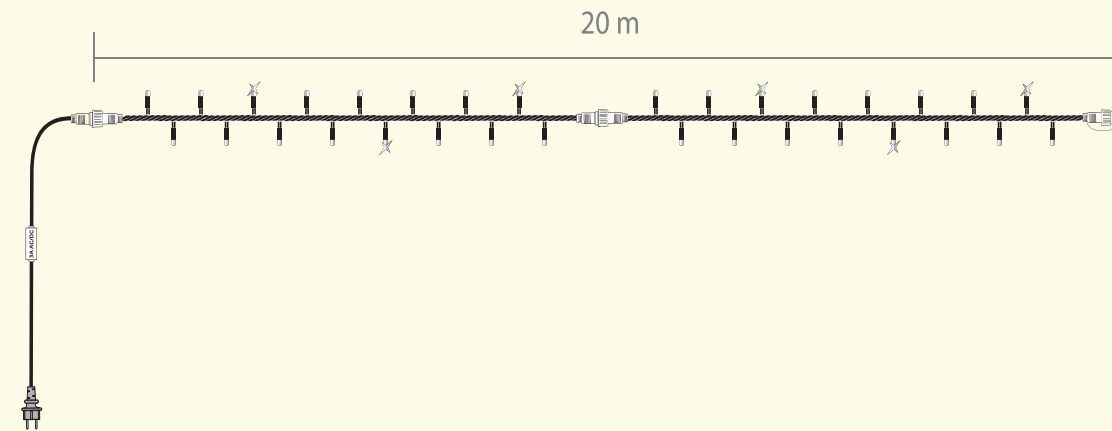
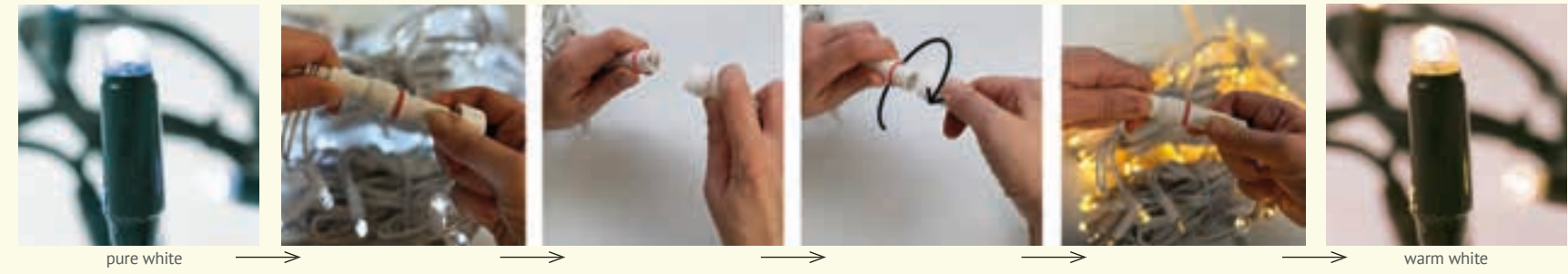

FLASH

◀▶	LED	FLASH	P (W)	🔌	■
20m	128 🌞	32 🌟	11,5	5	530WWF

PRODUCT DETAILS

2 products in 1!
Your garland can be either warm white or pure white.

Reverse the connection to obtain pure white/pure white flash or warm white/warm white flash. See DUO COLORS® Decor Collection.



SPARKLIGHT® LED+ GARLANDS

slowflash or static

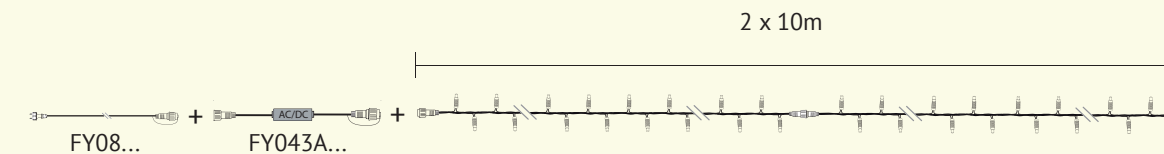

SLOWFLASH

◀▶	LED	SLOWFLASH	P (W)	☑	■	□
20m	108 ●	52	10	5	FL590F+	FL590BF+
20m	108 ●	52	10	5	FL590WF+	FL590WBF+
20m	108 ●	52	10	5	FL590BLF+	
20m	108 ●	52	10	5	FL590RF+	

STATIC

◀▶	LED	SLOWFLASH	P (W)	☑	■	□
20m	160 ●	-	10	5	FL590+	FL590-B+
20m	160 ●	-	10	5	FL590W+	FL590W-B+
20m	160 ●	-	10	5	FL590BL+	
20m	160 ●	-	10	5	FL590R+	

ACCESSORIES NEEDED TO OPERATE THESE PRODUCTS

			■	□
1,50 m	230V power supply cable		FY08+	FY08-B+
0,30 m	bridge rectifier	690W max	FY043A+	FY043A-B+
0,20 m	bridge rectifier	230W max	FY041A+	FY041A-B+

PRODUCT INFO

INNOVATION Our optimized LED+

-15% reduction in electrical consumption (on average) +brightness

- Blachere exclusive
- Registered design
- High brightness
- Shock resistant IK06
- Long lifespan
- Stable colour
- IP 66/69 protection rating. Maximum rating allowed for a 230V product
- Flexible connectivity thanks to the extensive Octopus 230V by Blachere range.

2 YEARS GUARANTEE

conditions : contact us

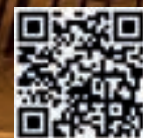

SPARKLIGHT® GARLANDS

flash or static

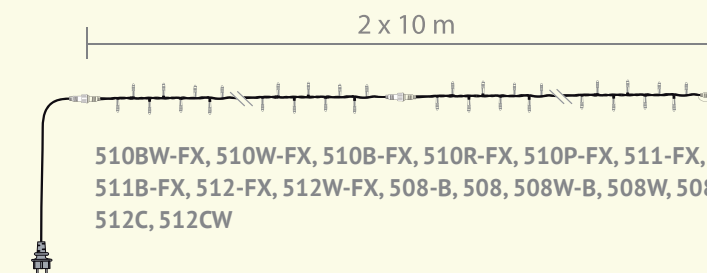
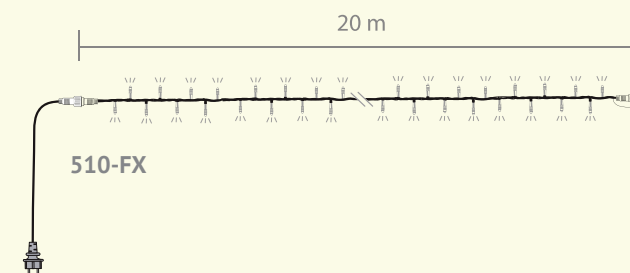
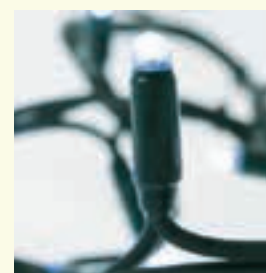
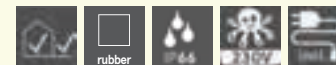

510BW-FX, 510W-FX, 510B-FX, 510R-FX, 510P-FX, 511-FX, 511B-FX, 512-FX, 512W-FX, 508-B, 508, 508W-B, 508W, 508B, 512C, 512CW

100% FLASH

◄	LED	FLASH	P (W)	☑	■	□
20m	-	80	6	5	510-FX	

FLASH

◄	LED	FLASH	P (W)	☑	■	□
20m	190	30	8	5	512-FX	
20m	190	30	8	5	512W-FX	
20m	150	50	12	5	511-FX	511B-FX
20m	150	50	12	5	510W-FX	510BW-FX
20m	150	50	12	5	510B-FX	
20m	150	50	12	5	510R-FX	
20m	150	50	15,5	5	510P-FX	

STATIC

◄	LED	FLASH	P (W)	☑	■	□
20m	200	-	15	5	508	508-B
20m	200	-	15	5	508W	508W-B
20m	200	-	15	5	508B	
20m	120	-	8	5	512C	
20m	120	-	8	5	512CW	

PRODUCT INFO

Proven reliability.
Power supply with connecting socket included.
Wide range of Octoplus 230V by Blachere accessories available.

High flash concentration on FX models.
Increased waterproofing thanks to optimum protection rating.



SPARKLIGHT® 24V GARLANDS

flash or static

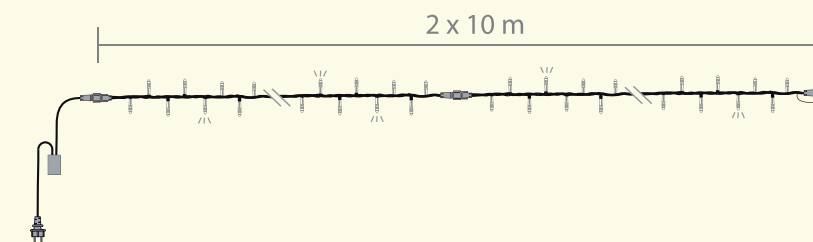

WITH PVC CABLE

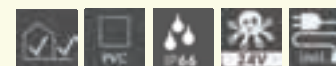

FLASH

◀▶	LED	FLASH	P (W)	IP	■
20m	168	28	5	5	FL502-FX
20m	168	28	5	5	FL502W-FX
20m	168	28	5	5	FL502B-FX
20m	168	28	5	5	FL502R-FX

STATIC

◀▶	LED	FLASH	P (W)	IP	■
20m	196	-	5	5	501W

WITH RUBBER CABLE (PERMANENT USE)

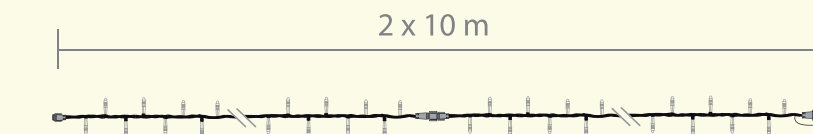
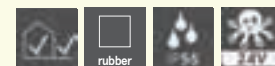

STATIC

◀▶	LED	FLASH	P (W)	IP	■
20m	196	-	6,2	4	501CW
switch-mode power supply 24V dc 25W - sold separately					PRTR24V

PRODUCT INFO

Very low voltage ideal for safe installations within the reach of the public.
High protection rating to withstand dirt and moisture.
Long lengths made possible by connecting several garlands using one transformer.

Ref 501CW: more durable rubber cable, ideal for permanent use.

Wide range of Octopus 24V by Blachere accessories

TWIGS GARLANDS

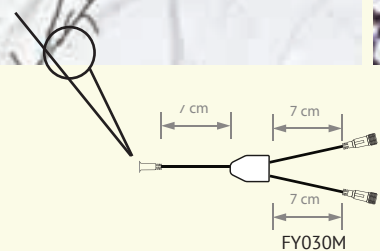

PRODUCT INFO

Save 40 % on installation time!

Quick and easy tree wiring thanks to the double-output Y connector FY030M.

Operates with 24V transformer 24V FY04BRIN.

3 outputs for twig BRIN180/180W supplied with 3 x 2m extension leads for connecting up to 6 sets of 3 branches on a single power supply.

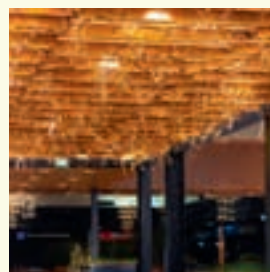

SET OF 3 TWIGS

◆	LED	P (W)	■
3X1.80m	3X161	3x5	BRIN180
3X1.80m	3X161	3x5	BRIN180W
24V - 3 output transformer for BRIN180/180W			FY04BRIN
double output Y connector			FY030M

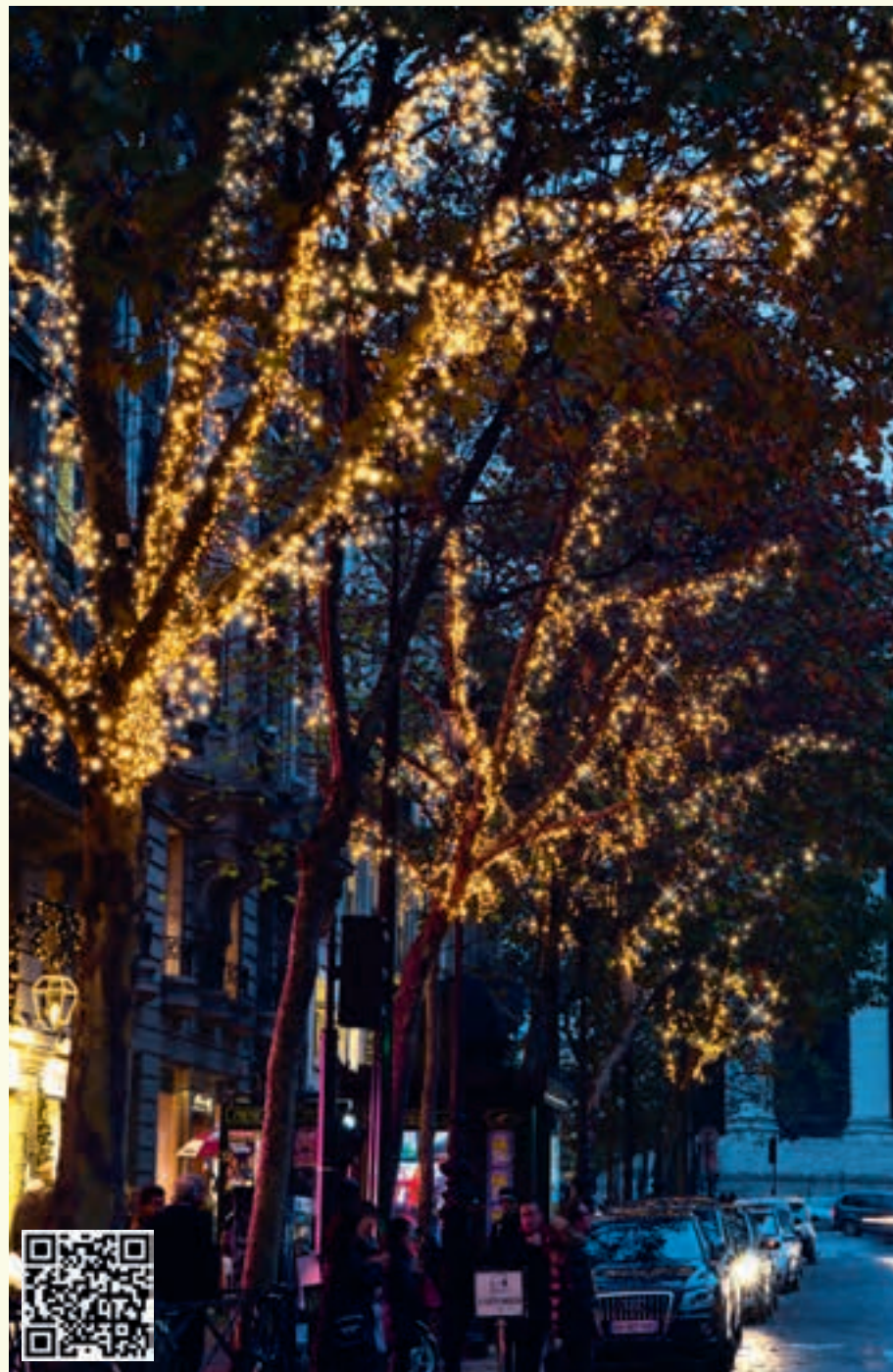

CHERRYLIGHT® GARLAND

multicoloured

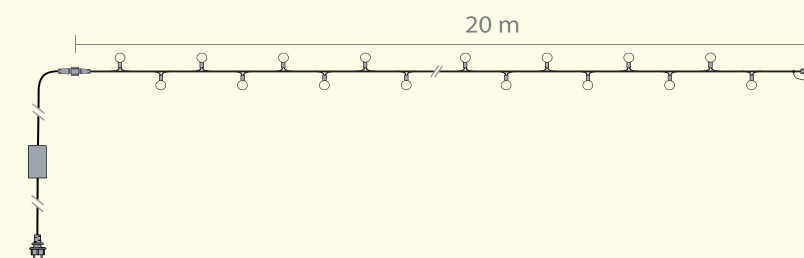
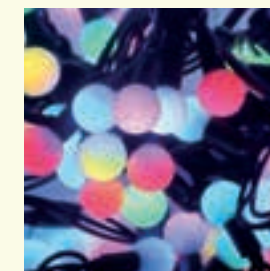

◆	LED	P (W)	□	■
20.0m	160	4	3	FL555C





SPARKLIGHT LED SUPER BRIGHT® GARLAND

flash

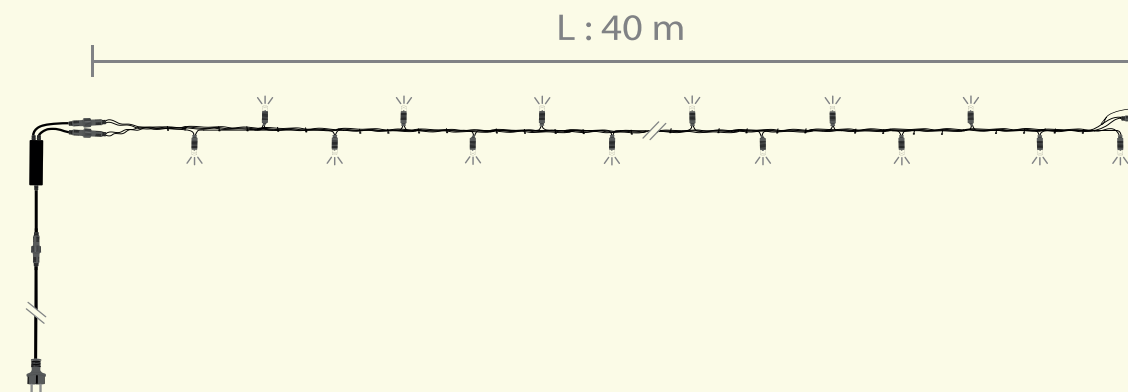
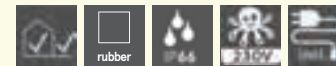

FLASH

◆	FLASH	P (W)	☐	■
40m	80	20	2	560-F

PLUS PRODUIT

INNOVATION 2024 Our optimized LED+

-15% reduction in electrical consumption (on average) +brightness

Recreate the most beautiful avenue in the world in your town!
A product and animation exclusively developed for the Champs-Élysées is now available to all our clients.

Blachere Illumination, the official supplier of the «Champs-Élysées» Committee.



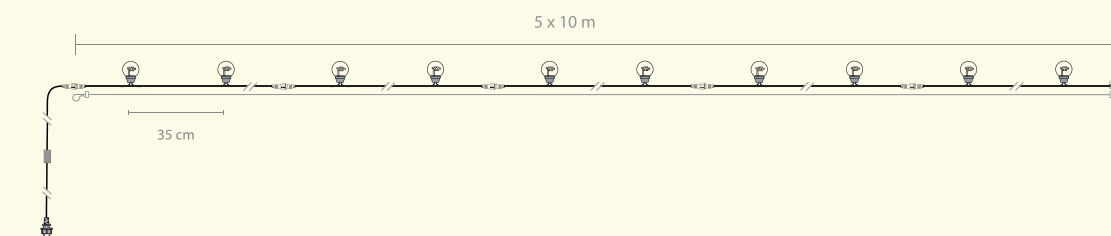
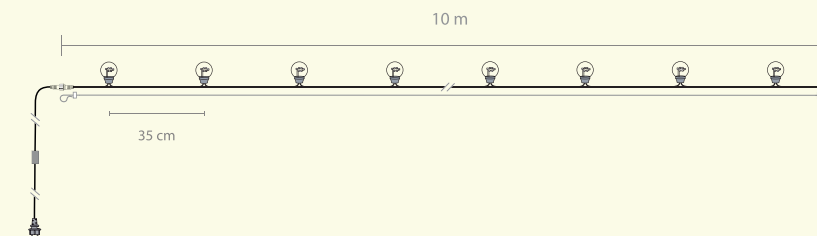

LEDMOSPHERE GARLANDS

static



STATIC

	LED	P (W)		■
10.0m	30 	14	10	600W
50,0m	150 	70	2	650W

PRODUCT INFO

Garland packaged in rolls and mounted on a steel wire which will allow an easy installation and a greater resistance.

Compatible with the Octoplus 230V range. Carabiners supplied.

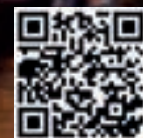

GARLANDS

with B22 sockets

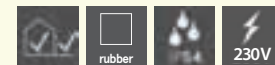

N NEW CONSTRUCTION 2025

ROLLS OF B22 SOCKET GARLANDS - PLUG NOT INCLUDED

◆	description	cable section	B22	B22	B22
100.00m	roll of garland 1 socket/m	2 x 1,5 mm ²	■ GR098C	■ GR098CN	
100.00m	roll of garland 2 sockets/m	2 x 1,5 mm ²	■ GR099C	■ GR099CN	
100.00m	roll of garland 3 sockets/m	2 x 1,5 mm ²	■ GR100C	■ GR100CN	□ GR100C-B
50.00m	roll of garland 4 sockets/m	2 x 1,5 mm ²	■ GR112C	■ GR112CN	
50.00m	roll of garland 5 sockets/m	2 x 1,5 mm ²	■ GR113C	■ GR113CN	

GARLANDS WITH B22 SOCKETS - PLUG INCLUDED

◆	description	cable section	B22	B22
9.00m	garland of 20 sockets	2 x 1,5 mm ²	■ GR1C	■ GR1CN
15.00m	garland of 40 sockets	2 x 1,5 mm ²	■ GR2C	

PRODUCT INFO

Customise your garland with different bulbs suggested on p185 and make up your own eye-catching effect.

Replace your old incandescent bulbs with LED bulbs, new technology with vintage look but more economical so more ecological.



LDL B22/E27 range (registered design)



LDLH B22 SMD range



LDLFL-B22



F722-L / F732-L



B22/E27 BULBS & STARFLASH®

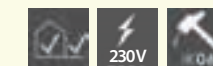

PRODUCT INFO

The LDL series is a classic of Blachere lighting. A registered model, the particular arrangement of the LEDs in the bulb globe gives a «filament effect» similar to the incandescent bulbs of yesteryear.

The polycarbonate globe guarantees an increased solidity (IK06).

The LDLFL-B22 recreates the effect of a flame, regardless of the mounting direction.

F722-L / F732-L

A historical product that is easy to use on a B22 lampholder.
Produces 1 flash approximately every 3 seconds.



description	B22	E27	B22	B22	B22	
type of globe	polycarbonate	polycarbonate	polycarbonate	polycarbonate	polycarbonate	
ø of globe	45 mm	45 mm	45 mm	36 x 115 mm		
voltage	230V	230V	230V	230V	230V	
intensity	3,68VA	3,68VA	3,68VA		0,5J	2J
wattage	16 mA max/ 0,5W	16 mA max/ 0,5W	16 mA max/ 0,5W	3W	1W	1,3W
packing	set of 25	set of 25	set of 25	unit	unit	unit
pure white	LDL11-B22	LDL11-E27	LDLH11		F722-L	F732-L
warm white	LDL11W-B22	LDL11W-E27	LDLH11W			
amber	LDL12-B22	LDL12-E27	LDLH12	LDLFL-B22		
red	LDL13-B22	LDL13-E27	LDLH13			
blue	LDL14-B22	LDL14-E27	LDLH14			
green	LDL16-B22	LDL16-E27	LDLH16			
pink	LDL18-B22	-	LDLH18			

Low power consumption bulb - Note : use the appropriate power (16mA i.e 3,68VA) to calculate the rating of your network (cable section area, circuit breaker, power required etc.). Use 0,5W per bulb to calculate the power consumption.

In outdoor use, must be mounted on garland with B22 sockets minimum IPX4 with waterproof seal fitted.



JOYLIGHT® LED+ CURTAINS

slowflash or static

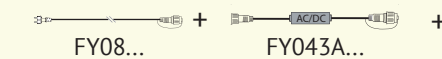
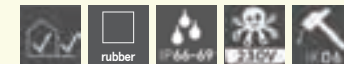

requires 230V power supply cable L: 1,50m FY08+ type... and bridge rectifier FY043+ type...

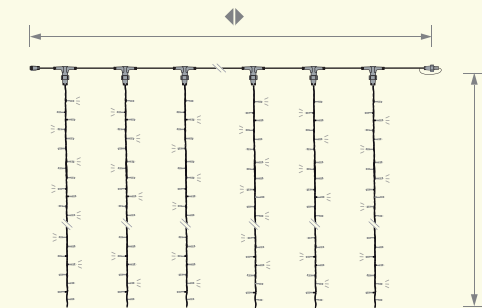

SLOWFLASH

◆	◀	LED	SLOW FLASH	P (W)	□	☐	■	□
1,5m	2m	150	60	13	15	27	FL74F+	FL74BF+
1,5m	2m	150	60	13	15	27	LF74WF+	FL74WBF+
3m	2m	240	120	25	15	18	FL70F+	FL70BF+
3m	2m	240	120	25	15	18	FL70WF+	FL70WBF+
5m	2m	360	180	60	15	9	FL75F+	FL75BF+
5m	2m	360	180	60	15	9	FL75WF+	FL75WBF+
7m	2m	510	240	60	15	9	FL72F+	FL72BF+
7m	2m	510	240	60	15	9	FL72WF+	FL72WBF+
10m	2m	690	360	69	15	9	FL79F+	FL79BF+
10m	2m	690	360	69	15	9	FL79WF+	FL79WBF+

STATIC

◆	◀	LED	SLOW FLASH	P (W)	□	☐	■	□
1,5m	2m	210	-	13	15	27	FL74+	FL74-B+
1,5m	2m	210	-	13	15	27	FL74W+	FL74W-B+
3m	2m	360	-	25	15	18	FL70+	FL70-B+
3m	2m	360	-	25	15	18	FL70W+	FL70W-B+
5m	2m	540	-	60	15	9	FL75+	FL75-B+
5m	2m	540	-	60	15	9	FL75W+	FL75W-B+
7m	2m	750	-	60	15	9	FL72+	FL72-B+
7m	2m	750	-	60	15	9	FL72W+	FL72W-B+
10m	2m	1050	-	69	15	9	FL79+	FL79-B+
10m	2m	1050	-	69	15	9	FL79W+	FL79W-B+

ACCESSORIES NEEDED TO OPERATE THESE PRODUCTS

◆	■	□
1,50 m	230V power supply cable	FY08+ FY08-B+
0,30 m	bridge rectifier	FY043A+ FY043A-B+
0,20 m	bridge rectifier	FY041A+ FY041A-B+



PRODUCT INFO

INNOVATION Our optimized LED+

-15% reduction in electrical consumption (on average) +brightness

- Blachere exclusive
- Registered design
- High brightness
- Shock resistant IK06
- Long lifespan
- Stable colour
- IP 66/69 protection rating. Maximum rating allowed for a 230V product
- Flexible connectivity thanks to the extensive Octoplus 230V by Blachere range.

2 YEARS GUARANTEE

conditions : contact us



JOYLIGHT LED SUPER BRIGHT® CURTAIN

flash

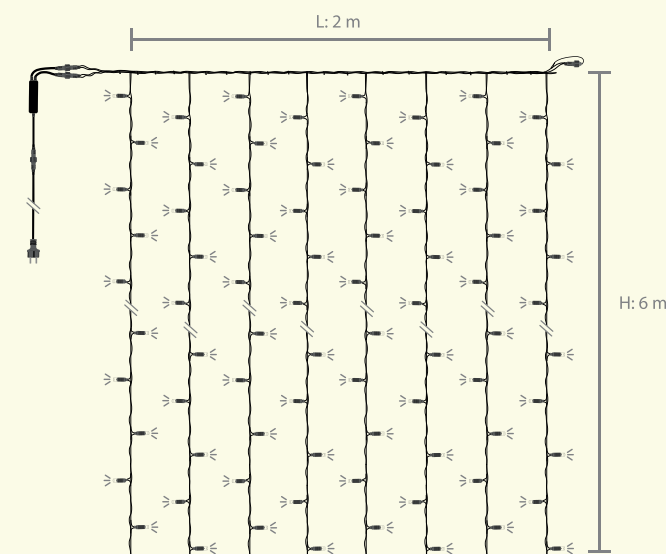
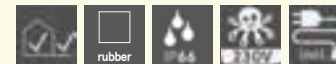

FLASH

◆	◆	FLASH	P (W)		☑	■
2m	6m	80	20	8	5	260-F

PRODUCT INFO

INNOVATION 2024 Our optimized LED+

**-15% reduction in consumption (on average)
+brightness**

Recreate the most beautiful avenue in the world in your town!
A product and animation exclusively developed for the Champs-Élysées is now available to all our clients.

Blachere Illumination, the official supplier of the «Champs-Élysées» Committee.



JOYLIGHT® CURTAINS

flash or static

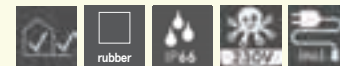

FLASH

◆	◀	LED	FLASH	P (W)	⏏	⏏	□
0.8m	2.0m	140 ●	28	14	14	30	21CBFX
0.8m	2.0m	140 ●	28	14	14	30	21CWBFX
1.5m	2.0m	210 ●	30	15	15	25	24CBFX
1.5m	2.0m	210 ●	30	15	15	25	24CBLFX
1.5m	2.0m	210 ●	30	15	15	25	24CRFX
1.5m	2.0m	210 ●	30	15	15	25	24CWBFX
3.0m	2.0m	420 ●	56	33	14	16	20CBFX
3.0m	2.0m	420 ●	56	33	14	16	20CBLFX
3.0m	2.0m	420 ●	56	33	14	16	20CRFX
3.0m	2.0m	420 ●	56	33	14	16	20CWBFX
5.0m	2.0m	900 ●	90	55	15	12	25CBFX
5.0m	2.0m	900 ●	90	55	15	12	25CBLFX
5.0m	2.0m	900 ●	90	55	15	12	25CRFX
5.0m	2.0m	900 ●	90	55	15	12	25CWBFX
7.0m	2.0m	1200 ●	120	80	15	8	22CBFX
7.0m	2.0m	1200 ●	120	80	15	8	22CWBFX
10.0m	2.0m	1200 ●	135	84	15	8	29CBFX
10.0m	2.0m	1200 ●	135	84	15	8	29CWBFX

STATIC

◆	◀	LED	FLASH	P (W)	⏏	⏏	□
1.5m	2.0m	342 ●	-	30	18	20	24C-B
1.5m	2.0m	342 ●	-	30	18	20	24CW-B
3.0m	2.0m	540 ●	-	35	18	15	20C-B
3.0m	2.0m	540 ●	-	35	18	15	20CW-B
5.0m	2.0m	900 ●	-	65	18	9	25C-B
5.0m	2.0m	900 ●	-	65	18	9	25CW-B
7.0m	2.0m	1080 ●	-	72	18	9	22C-B
7.0m	2.0m	1080 ●	-	72	18	9	22CW-B
10.0m	2.0m	1350 ●	-	58	18	10	29C-B
10.0m	2.0m	1350 ●	-	58	18	10	29CW-B

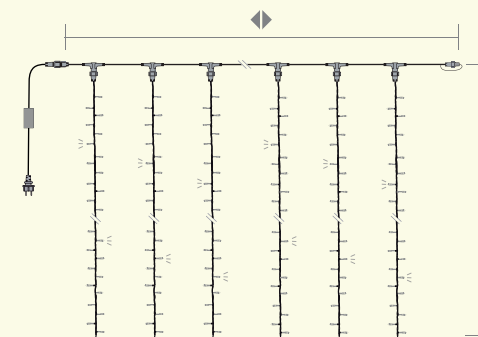

PRODUCT INFO

Ideal for decorating facades, trees or for cross-street motifs.

Up to 30 curtains on the same power supply.

Compatible with the entire range.

Connection options with the Octoplus 230V by Blachere® accessories.



ECO LIGHT CURTAINS

flash or static

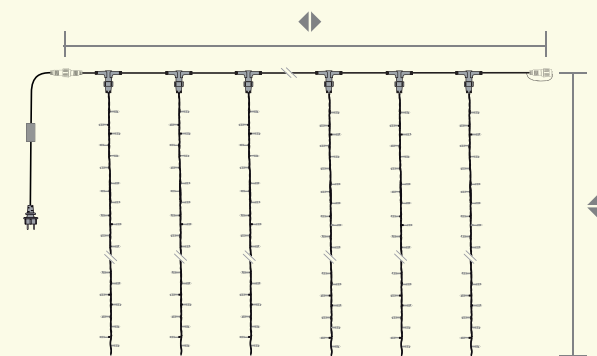
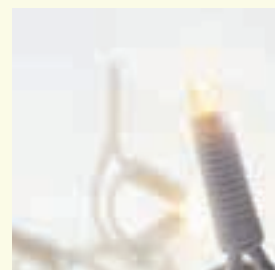
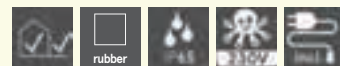

FLASH

◆	◀	LED	FLASH	P (W)	□	□	□
1.5m	2.0m	180	30	15	15	20	ECO24W-F
3.0m	2.0m	315	45	20	15	15	ECO20W-F
5.0m	2.0m	512	64	30	16	12	ECO25W-F

STATIC

◆	◀	LED	FLASH	P (W)	□	□	□
3.0m	2.0m	360	-	20	15	15	ECO20-B
3.0m	2.0m	360	-	20	15	15	ECO20W-B
7.0m	2.0m	750	-	50	15	7	ECO22-B
7.0m	2.0m	750	-	50	15	7	ECO22W-B
1.5m	2.0m	210	-	15	15	20	ECO24-B
1.5m	2.0m	210	-	15	15	20	ECO24W-B
5.0m	2.0m	576	-	30	16	12	ECO25-B
5.0m	2.0m	576	-	30	16	12	ECO25W-B
10.0m	2.0m	1050	-	55	15	6	ECO29-B
10.0m	2.0m	1050	-	55	15	6	ECO29W-B

PRODUCT INFO

Unbeatable value for money with proven reliability.

An extensive selection of accessories and connection options with Octoplus® 230V by Blachere® accessories.



JOYLIGHT® 24V CURTAINS

flash

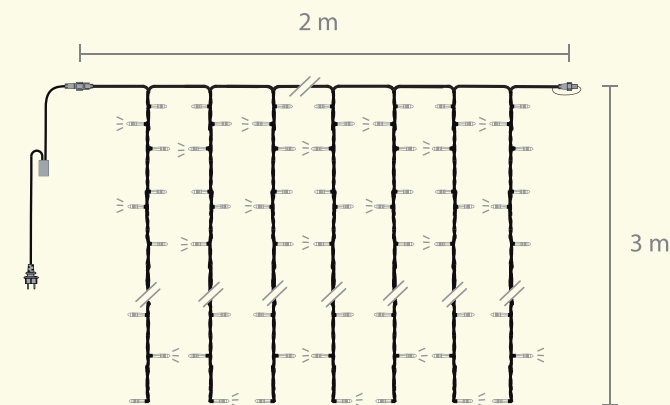
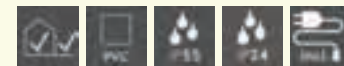

FLASH

◆	◀	LED	FLASH	P (W)	⌈⌋	⏏	□
3.0m	2.0m	300	60	12.5	15	2	FL203-FX
3.0m	2.0m	300	60	12.5	15	2	FL203B-FX
3.0m	2.0m	300	60	12.5	15	2	FL203P-FX
3.0m	2.0m	300	60	12.5	15	2	FL203R-FX
3.0m	2.0m	300	60	12.5	15	2	FL203W-FX

PRODUCT INFO

Unbeatable value for money with proven reliability.

An extensive selection of accessories and connection options with Octopus® 230V by Blachere® accessories.

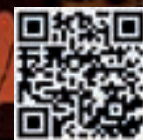

JOYLIGHT® CURTAINS

slowglow effect

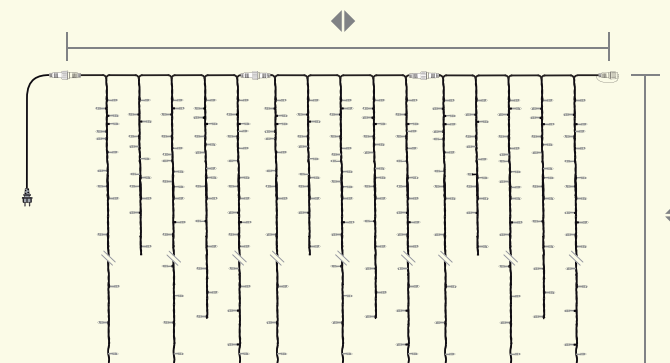
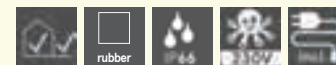

SLOWGLOW

◆	◀	SLOWGLOW	P (W)	⌈	⌋	□
1.5m	2.0m	120	16	15	13	24SG
1.5m	2.0m	120	16	15	13	24WSG
3.0m	2.0m	180	15	15	12	20SG
3.0m	2.0m	180	15	15	12	20WSG
5.0m	2.0m	210	17	15	12	25SG
5.0m	2.0m	210	17	15	12	25WSG
7.0m	2.0m	225	17	15	12	22SG
7.0m	2.0m	225	17	15	12	22WSG
10.0m	2.0m	270	15	15	13	29SG
10.0m	2.0m	270	15	15	13	29WSG

PRODUCT INFO

New animation exclusive to Blachere Illumination.
Gentle lighting snowflake effect.

Compatible with the entire range.
Connection options with 230V Octopus® accessories
by Blachere®

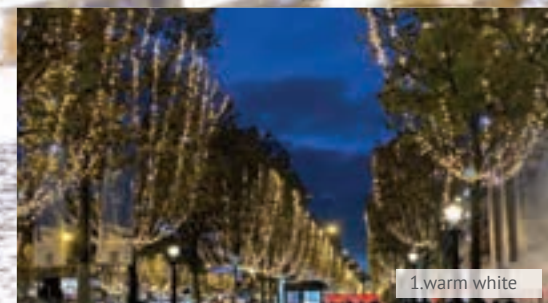

1.warm white



2.Flash



3.warm white + flash

EXCLUSIVE CONCEPT «SOBRILLANCE» CURTAINS

Champs-Élysées

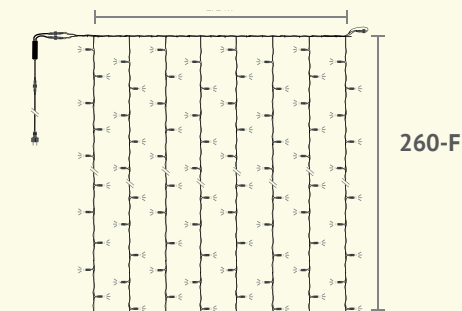
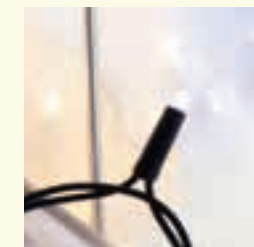

260-F

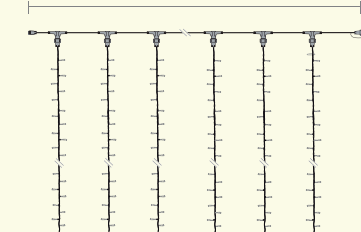

FL75W-B+, FL75W+, FL72W-B+,
FL72W+, FL79W-B+, FL79W+

FLASH JOYLIGHT LED SUPER BRIGHT® CURTAIN

◆	◆	FLASH	P (W)	□	□	■
2m	6m	80	20	8	5	260-F

STATIC LED+ CURTAINS

◆	◆	LED	P (W)	□	□	■	□
2m	5m	540	60	15	9	FL75W+	FL75W-B+
2m	7m	750	60	15	9	FL72W+	FL72W-B+
2m	10m	1050	69	15	9	FL79W+	FL79W-B+

ACCESSORIES NEEDED TO OPERATE THESE PRODUCTS

1,50 m	power supply cable			■	□	FY08+	FY08-B+
0,30 m	bridge rectifier		690W max			FY043A+	FY043A-B+
0,20 m	bridge rectifier		230W max			FY041A+	FY041A-B+

PRODUCT INFO

INNOVATION Our optimized LED+

-15% reduction in electrical consumption (on average) +brightness

Sobrillance is the combination of a static warm white curtain and a Super Bright flash curtain.

Vary the sequences with our remote controlled/programmable clock and create a living light show in your street!

On special request.



CHAMPS ÉLYSÉES «SCINTILLANCE» CURTAIN

with vertical animation

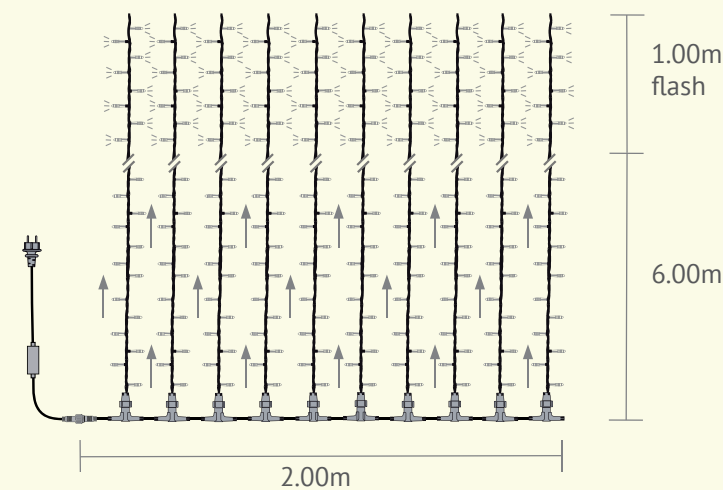

FLASH

◆	◀	LED	FLASH	P (W)	□	☐	☐
7.0m	2.0m	420 ●	80	55	10	-	ECO216W

PRODUCT INFO

Recreate the most beautiful avenue in the world wherever you are !

Product and animation developed exclusively for the Champs Elysées now available for all our customers.

Blachere illumination official supplier of the « Champs Elysées » Committee.

A PRO version that exactly reproduces the effect on the Champs Elysées and an ECO version with a simplified effect.

CHERRYLIGHT® CURTAINS

multicoloured

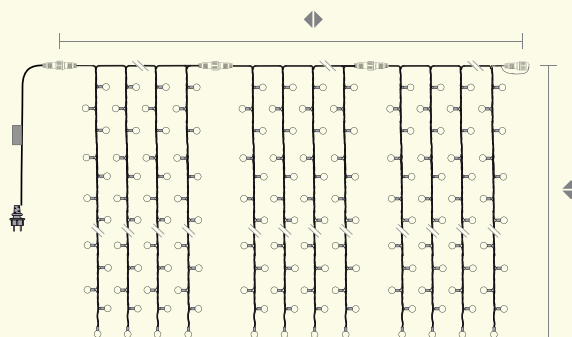
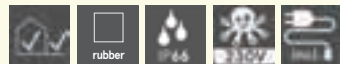

PRODUCT INFO

This curtain with opaque globes diffuses a uniform light in vibrant colours that changes randomly and automatically.

STATIC

◆	◆	LED	P (W)	☑	■
1.5m	2.0m	180	15	15	FL224C
3.0m	2.0m	300	25	10	FL220C



HONEYCOMB LIGHT® TREE NET

flash

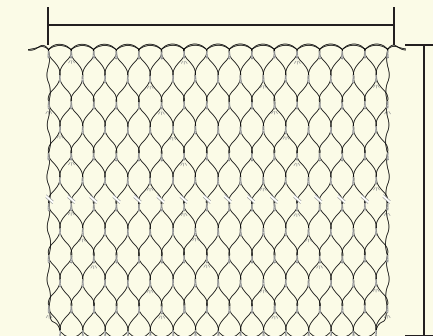
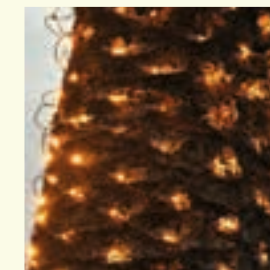

PRODUCT INFO

This net makes easy the decoration of tree trunks... with light. Thanks to its honeycomb mesh, it is placed around the trunk and adjusted to the diameter.

Ergonomic and practical, it will take you on average 10 times less time to dress your tree trunks than with a traditional garland!

The colour of the cable (brown) allows it to be less visible during the day and is exclusive to Blachere Illumination.

◆	◆	LED	SLOWFLASH	P (W)	☑	■
2.0m	2.0m	204	52	11	7	802W-F
3.0m	2.0m	306	78	16	5	803W-F
4.0m	2.0m	-	592	23	5	804WSF



STALACTITLIGHT DUO COLORS®

flash



pure white

warm white

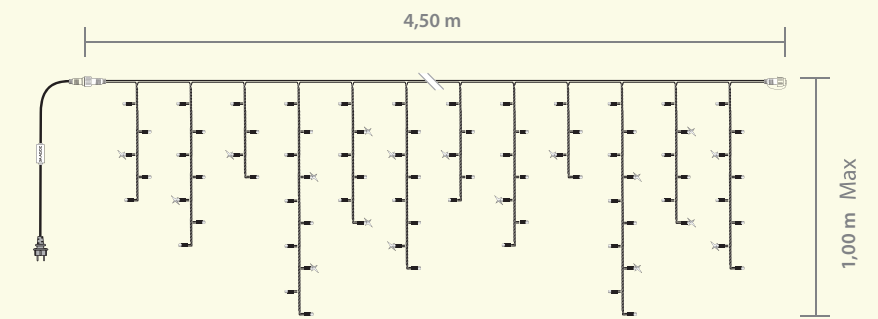

FLASH

◆	◀	LED	SLOWFLASH	P (W)	□	□	□
1.0m	4.5m	180	60	15	36	15	330BWWF

PRODUCT INFO

2 products in 1!
 Your garland can be either warm white or pure white.
 Reverse the connection to obtain pure white/pure
 white flash or warm white/warm white flash. See DUO
 COLORS® Decor Collection.



STALACTITLIGHT® LED+

slowflash or static

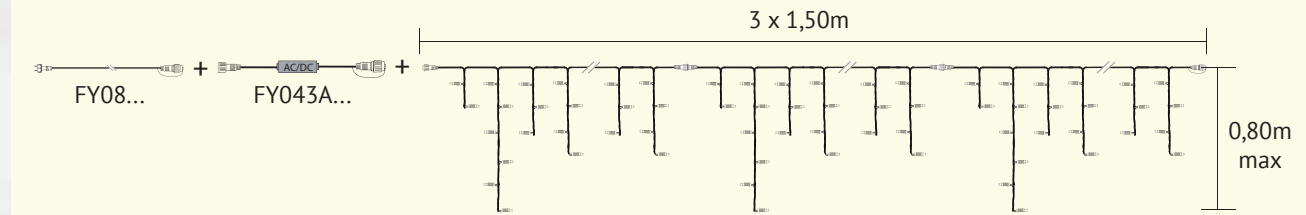
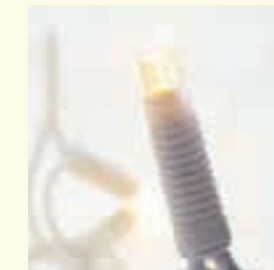

SLOWFLASH

◆	◀	LED	SLOWFLASH	P (W)	⌈⌋	⌈⌋	□
0.8m	4.5m	120	60	13	48	20	FL390BF+
0.8m	4.5m	120	60	13	48	20	FL390WBF+

STATIC

◆	◀	LED	SLOWFLASH	P (W)	⌈⌋	⌈⌋	□
0.8m	4.5m	180	-	13	48	20	FL390-B+
0.8m	4.5m	180	-	13	48	20	FL390W-B+

ACCESSORIES NEEDED TO OPERATE THESE PRODUCTS

		□	■
1,50 m	power supply cable	FY08-B+	FY08+
0,30 m	bridge rectifier	FY043A-B+	FY043A+
0,20 m	bridge rectifier	FY041A-B+	FY041A+

PRODUCT INFO

INNOVATION Our optimized LED+

-15% reduction in consumption (on average) +brightness

- Blachere exclusive
- Registered design
- High brightness
- Shock resistant IK06
- Long lifespan
- Stable colour
- IP 66/69 protection rating. Maximum rating allowed for a 230V product
- Flexible connectivity thanks to the extensive Octoplus 230V by Blachere range.

2 YEARS GUARANTEE

conditions : contact us



STALACTITLIGHT®

flash or static

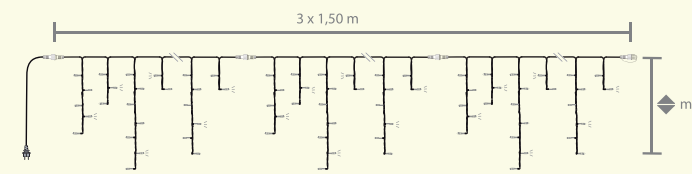
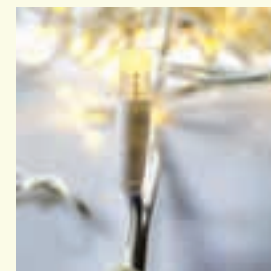
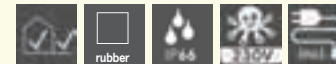

352-FX / 352W-FX / 352R-FX / 352B-FX / 354-FX
354W-FX / 352 / 352W / 354 / 354W

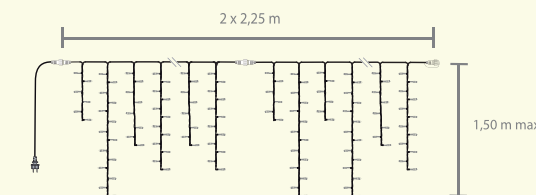

353C / 353CW

FLASH

◆	◀	LED	FLASH	P (W)	□	□	□
0.6m	4.5m	156	48	10	48	15	352-FX
0.6m	4.5m	156	48	10	48	15	352W-FX
0.6m	4.5m	156	48	10	48	15	352B-FX
0.6m	4.5m	156	48	10	48	15	352R-FX
1.0m	4.5m	180	60	10	36	15	354-FX
1.0m	4.5m	180	60	10	36	15	354W-FX

STATIC

◆	◀	LED	FLASH	P (W)	□	□	□
0.6m	4.5m	180	-	10	48	15	352
0.6m	4.5m	180	-	10	48	15	352W
1.0m	4.5m	240	-	12	36	15	354
1.0m	4.5m	240	-	12	36	15	354W
1.5m	4.5m	320	-	16	32	15	353C
1.5m	4.5m	320	-	16	32	15	353CW

PRODUCT INFO

An absolute must since its creation, this product is a best-seller owing to its reliability. Can be divided into sections for greater adaptability.

Compatible with the entire range. Connection options with 230V Octopus® accessories by Blachere®.



ECO STALACTITES

flash

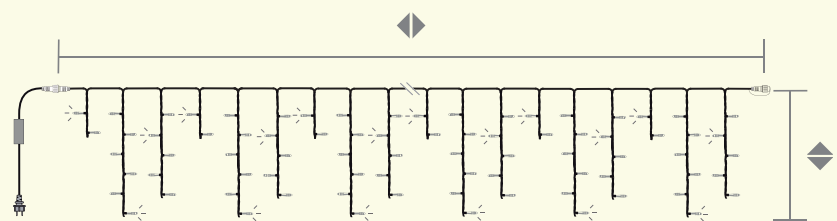
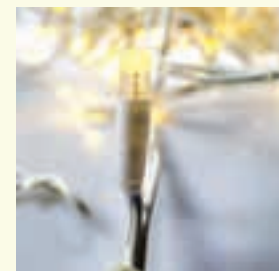
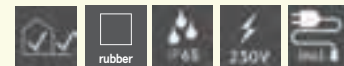

FLASH

◆	◀	LED	FLASH	P (W)	□	□	□
0.8m	4.5m	90	30	9	30	15	ECO350F
0.8m	4.5m	90	30	9	30	15	ECO350WF

PRODUCT INFO

Unbeatable value for money and proven reliability.

A wide choice of accessories and connection options with Octopus® by Blachere® accessories.



FIR GARLAND STALACTITES

flash

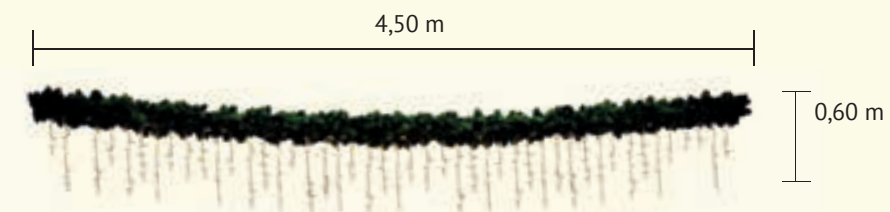

◆	◀	LED	FLASH	P (W)	⏏	🔌	□
0.6m	4.5m	156 ●	48	13	48	15	GP138L
0.6m	4.5m	156 ●	48	13	48	15	GP139L-W

PRODUCT INFO

A classic choice for traditional street decorations.

Quick connection accessories, extension leads, multi-socket connectors, 230V Octoplus by Blachere®.



CEILINGS

flash or static

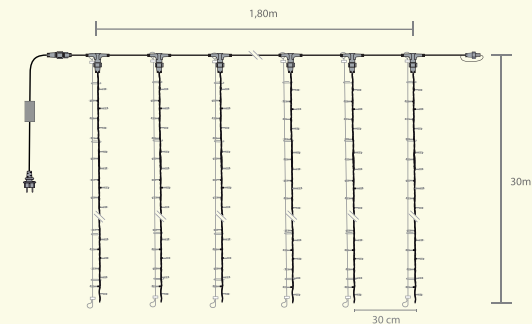
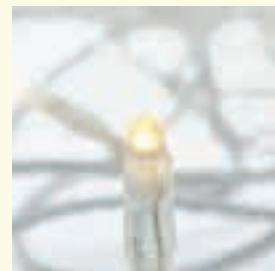
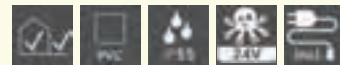

FLASH

◆	◀	LED	FLASH	P (W)	⌈	⌋	■
30.0m	2.0m	588	98	30	7	3	414-FX
30.0m	2.0m	588	98	30	7	3	414W-FX

STATIC

◆	◀	LED	FLASH	P (W)	⌈	⌋	■
30.0m	2.0m	686	-	30	7	3	414
30.0m	2.0m	686	-	30	7	3	414W

PRODUCT INFO

Cover up to 180m² with a single power supply at a lower cost.
 The 24V/100W transformer for outdoor use, included with the 414-FX and 414W-FX garlands, allows three modules to be connected to a single transformer. Each string is reinforced with a micro-steel wire for greater durability.



DUO COLORS® BRAIDS

flash



pure white

warm white



micro steel wire

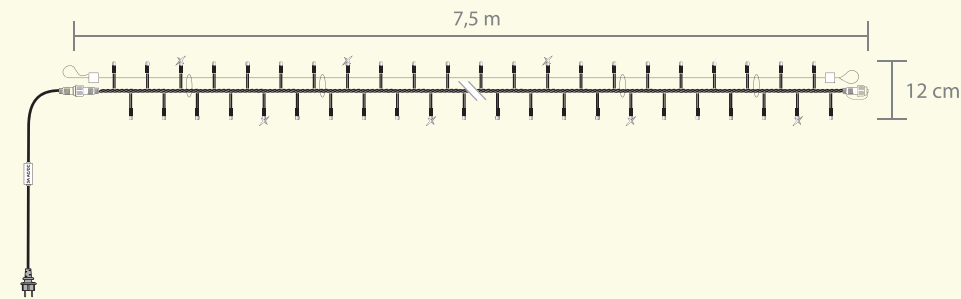

FLASH

Ø	◆	LED	FLASH	P (W)	☑	□
12.0m	7.5m	192	48	12	10	TSL4WWF

PRODUCT INFO

2 products in 1!
 Your garland can be either warm white or pure white.
 Reverse the connection to obtain pure white/pure
 white flash or warm white/warm white flash. See DUO
 COLORS® Decor Collection.



LED+ BRAIDS

slowflash

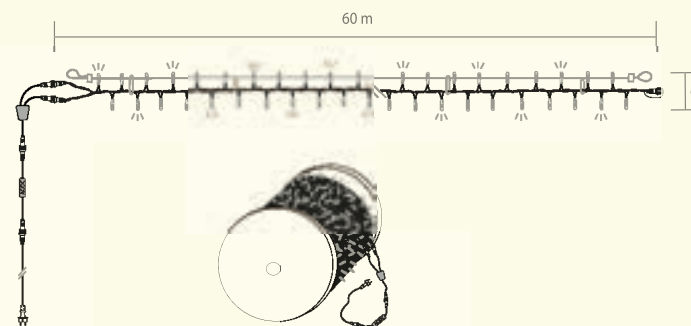
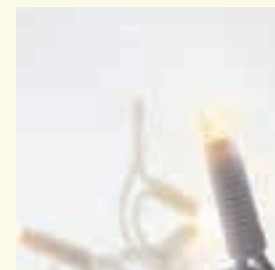

SLOWFLASH

Ø	◀▶	LED	SLOWFLASH	P (W)	📺	□
6.0m	60.0m	648 ●	312 ☀	60	2	TSL60+
6.0m	60.0m	648 ●	312 ☀	60	2	TSL60W+

PRODUCT INFO

«Ready-to-install» crossing with high light density. Mounted on a coated ø3mm steel cable. Features quick connection accessories, multi-socket connectors, and an animation kit.



BRAIDS

flash or static

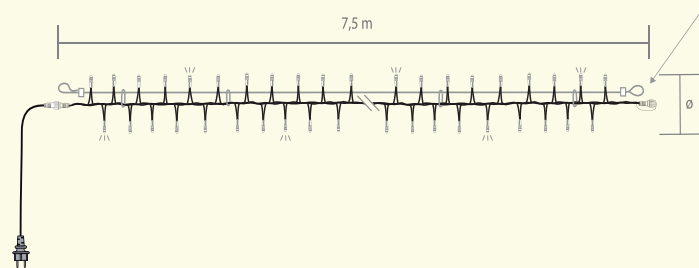
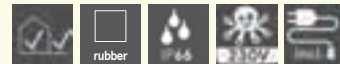

FLASH

Ø	◀▶	LED	FLASH	P (W)	☑	☐
12.0m	7.5m	210 ●	30	13	13	TSL3FX
12.0m	7.5m	210 ●	30	13	13	TSL3WFX

STATIC

Ø	◀▶	LED	FLASH	P (W)	☑	☐
6.0m	7.5m	240 ●	-	13	13	TSL2
6.0m	7.5m	240 ●	-	13	13	TSL2W

PRODUCT INFO

«Ready-to-install» crossing with high light density. Mounted on a coated ø3mm steel cable. Features quick connection accessories, multi-socket connectors, and an animation kit.



ECO BRAIDS

flash

N

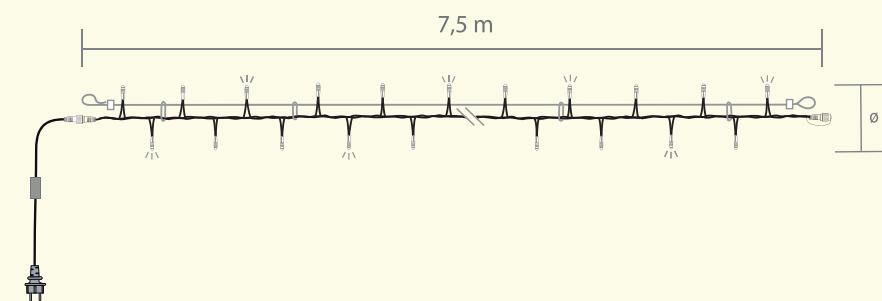
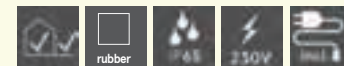

FLASH

◆	LED	FLASH	P (W)	☑	☐
7,5m	160	20	10	15	ECOXL3F
7,5m	160	20	10	15	ECOXL3WF

PRODUCT INFO

Unbeatable value for money and proven reliability.

A wide choice of accessories and connection options with Octoplus® by Blachere® accessories.



NICIA® BRAIDS

flash

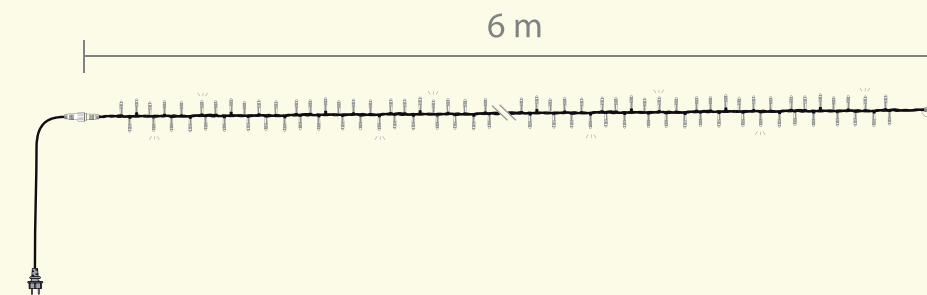

FLASH

∅	◄	LED	FLASH	P (W)	☑	☐
6.0m	6.0m	432 ●	48	23	9	558-FX
6.0m	6.0m	432 ●	48	23	9	558W-FX

PRODUCT INFO

Unbeatable value for money and proven reliability.

A wide choice of accessories and connection options with Octoplus® by Blachere® accessories.



TSLWW-W + ITGL111

TWO-TONE BRAIDS

dropdown

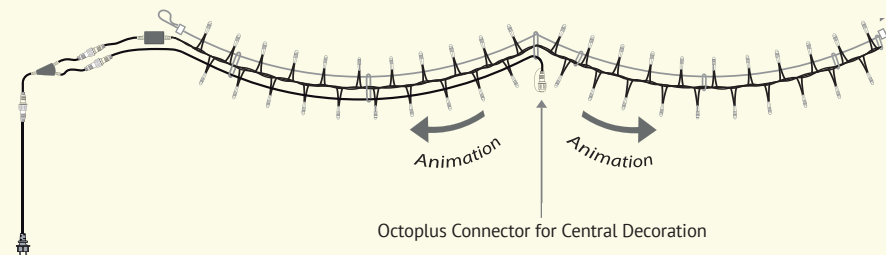
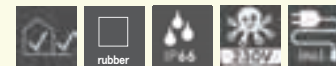

DROPDOWN

Ø	◀▶	LED	FLASH	P (W)	☑	☐
12cm	6.0m	240 ● ●	-	55	-	TSLBL-W
12cm	6.0m	240 ● ●	-	55	-	TSLWW-W

PRODUCT INFO

Discover our two-tone blue/white or warm white/pure white garlands, ideal for elegant decorations. Equipped with scrolling light effects and connectable to hanging lights, they create a magical, sophisticated atmosphere for all your festive occasions.

SWAG GARLANDS

pre-lit

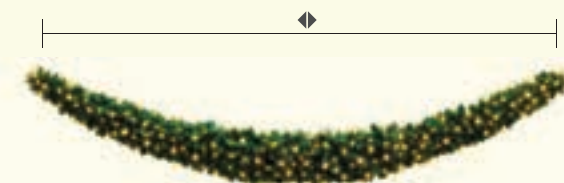
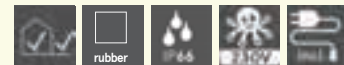

PRODUCT INFO

A timeless classic for traditional street decorations. Quick connection accessories, extensions, multi-socket connectors, and Octoplus 230V by Blachere®.

SWAG GARLAND PER UNIT

Ø	↔	LED	P (W)	🔌	■
35cm	3.0m	400 ●	30	6	GP303W
35cm	4.0m	500 ●	38	4	GP304W



FIR GARLANDS

pre-lit

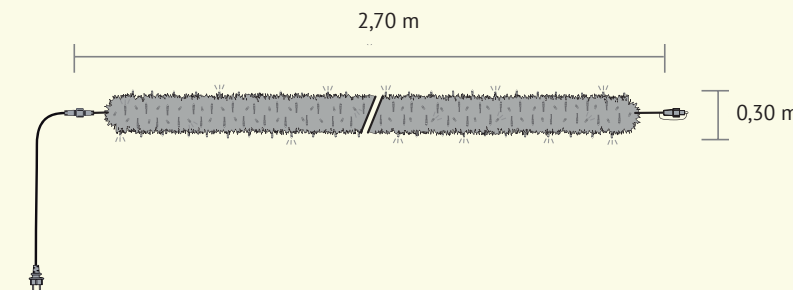

PRODUCT INFO

Great classic for traditional street decorations.

Quick-fit accessories, extension leads, multi-socket connectors Octoplus® 230V by Blachere®.

FLASHS

Ø	↔	LED	FLASH	P (W)	🔌	■
30cm	2.7m	180 ●	60 ☀	11	10	GP134LWFX

STATIC

Ø	↔	LED	P (W)	🔌	■
30cm	2.7m	240 ●	11	10	GP134L-W



HANGING BOUQUETS

static

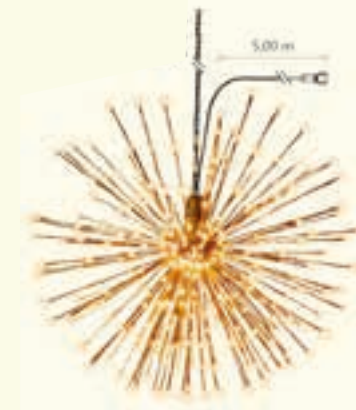
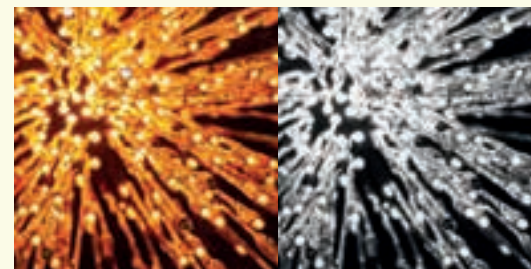

drawing of installation:

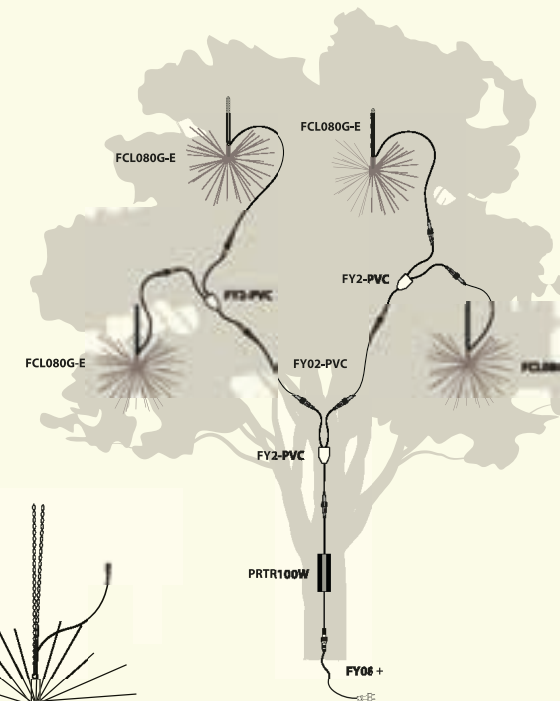
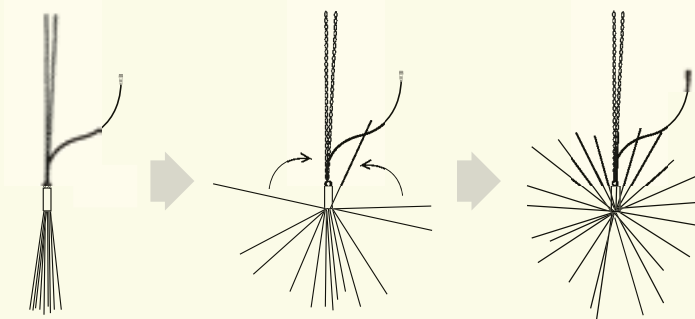

Installation sample

INDOOR



Ø	◀▶	LED	FLASH	P (W)	
80cm	-	441 ●	63	18	FCL080A
80cm	-	441 ●	63	18	FCL080G
Indoor transformer for FCL bouquet - sold separately				25	PRTR24VI

OUTDOOR



Ø	◀▶	LED	FLASH	P (W)	
80cm	-	441 ●	63	18	FCL080A-E
80cm	-	441 ●	63	18	FCL080G-E
Outdoor transformer for FCL bouquet - sold separately				25	PRTR24V

PRODUCT INFO

The hanging bouquets animated with flash with a gold or silver decoration, good daytime effect.

Working with a PRTR24VI or PRTR24V transformer - sold separately.
Compatible with 24V Octopus extension leads.

HANGING MOTIFS

X-Led effect

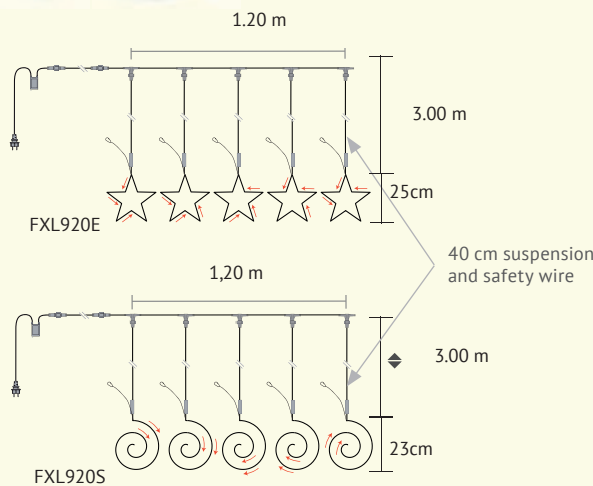
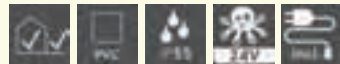

PRODUCT INFO

Ideal for embellishing your trees or hanging from strand lights. Enjoy exclusive Xled animations! Set includes 5 decorations.

Remember to attach the mini decorations with the suspension cables supplied.

SET OF 5 DECORATIONS

Ø	◄	◆	LED SMD	P (W)	■
25cm	1.2m	3.0m	270	25	FXL920E
23cm x 20cm	1.2m	3.0m	270	25	FXL920S



HANGING SPARKLING STARS

animated

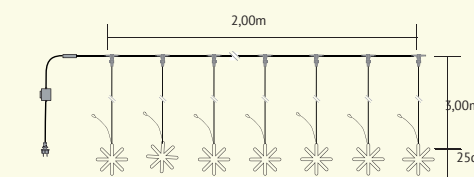

Refs : FL900xx

octoplus 230V

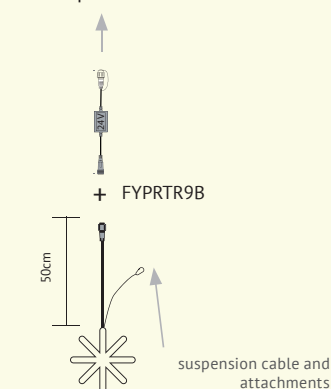

Refs : G-FL900xx

PRODUCT INFO

Discover the two-tone warm white/cool white glow: 2 effects in 1, exclusive to Blachere!
A best-seller with a patented design, this product provides smooth animation and an elegant daytime effect thanks to the white polycarbonate. Easy to install on trees or ropes with the hooks included. Available individually or in packs of 10.

SET OF 10 STARS

Ø	◄	◆	LED	P (W)	■
25cm	2.0m	3.0m	10	18	FL900E
25cm	2.0m	3.0m	10	18	FL900EW
25cm	2.0m	3.0m	10	18	FL900EWW
25cm	2.0m	3.0m	10	18	FL900EM

INDIVIDUAL STAR

Ø	◄	◆	LED	P (W)	□
25cm	-	-	1	3	G-FL900
25cm	-	-	1	3	G-FL900WW

230V -> 24V transformer with Octoplus connector

FYPRT9B

HANGING BALLS

flame effect

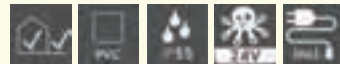

60 cm suspension and securing cable

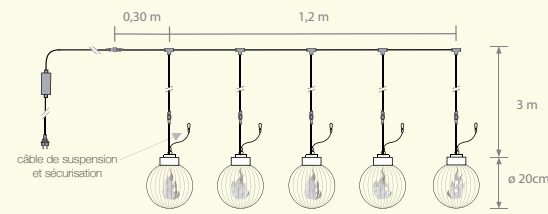

octoplus 230V



FYPRTR9



50cm

G-FL920LU

PRODUCT INFO

Perfect for decorating trees or hanging from strand lights. Recreate the warm atmosphere of candlelight with a unique sparkling animation.

Add a fashionable retro touch to your decorations! Available in packs of 5 GLOBES or individually.

SET OF 5 SPHERES

Ø	◀	◆	LED	P (W)	■
20cm	1.2m	3.0m	5	18	FL920LU

INDIVIDUAL SPHERE

Ø	◀	◆	LED	P (W)	■
20cm	-	-	1	3	G-FL920LU

230V -> 24V transformer with Octoplus connector

FYPRTR9



HANGING BALLS

multicoloured RGB

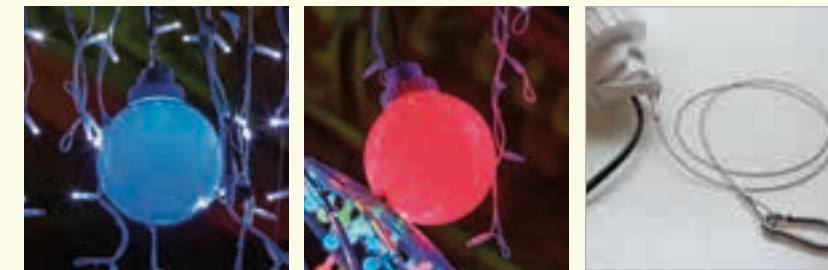

60 cm suspension and securing cable

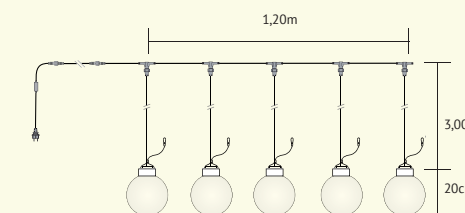

octoplus 230V



FYPRTR9



50cm

G-FL920M

PRODUCT INFO

Perfect for decorating trees or hanging from ropes. Create a colourful pop atmosphere RGB animation, a unique effect!

Available in packs of 5 GLOBES or individually.

SET OF 5 SPHERES

Ø	◀	◆	LED	P (W)	■
20cm	1.2m	3.0m	5	24	FL920M

INDIVIDUAL SPHERE

Ø	◀	◆	LED	P (W)	■
20cm	-	0.5m	1	4.5	G-FL920M

230V -> 24V transformer with Octoplus connector

FYPRTR9





NOSTALGIA XL HANGING BULBS

flash

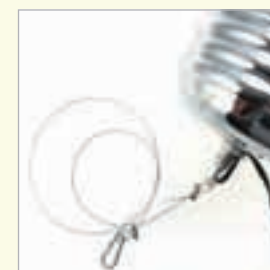
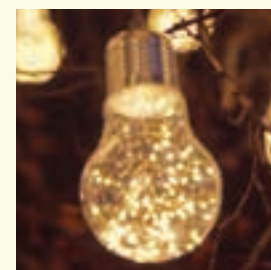
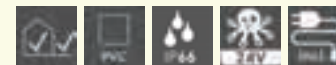

60 cm suspension and securing cable

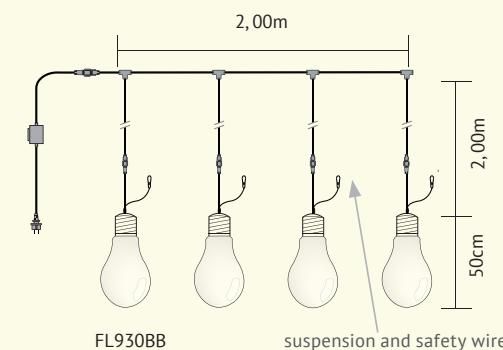

FL930BB

suspension and safety wire

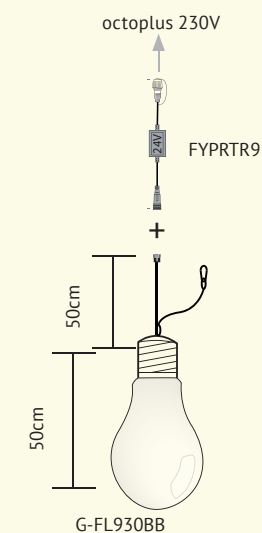

G-FL930BB

SET OF 4 BULBS

Ø	◀	◆	LED	FLASH	P (W)	■
28cm	2.0m	2.0m	400	200	18	FL930BB

INDIVIDUAL BULB

Ø	◀	◆	LED	FLASH	P (W)	■
28cm	-	0.5m	100	50	4	G-FL930BB
230V -> 24V transformer with Octoplus connector						FYPRT9

PRODUCT INFO

Perfect for enhancing your trees or hanging on cables, these oversized bulbs offer a captivating sparkle. Add a trendy retro touch to your decorations!

Available in a set of 4 bulbs with a transformer included, or individually.

Equipped with a stainless aluminum base for optimal durability.

HANGING SPHERES

micro led and flashes

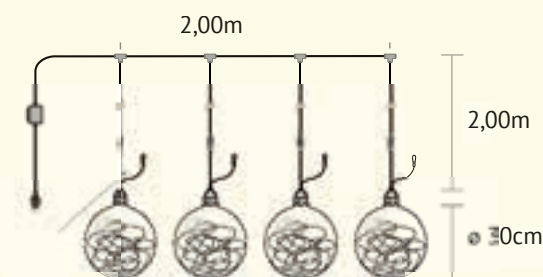
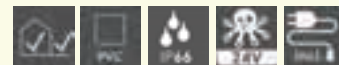

PRODUCT INFO

Set of 4 decorative light balls, perfect for illuminating your trees and creating a magical atmosphere. Easy to install, they give off a soft glow for your festive celebrations or seasonal decorations.

SET OF 4 SPHERES

∅	◀	◆	LED	FLASH	P (W)	■
30cm	2.0m	2.0m	400 ●	200 ☀	18	FL930A

HANGING BRANCHES

micro led

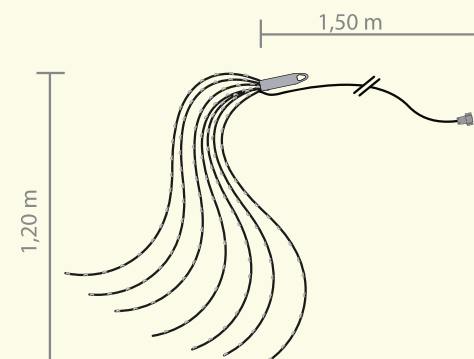

PRODUCT INFO

Super easy installation. It will ideally decorate lamp posts and facades.

Accessories sold separately.

◆	LED	P (W)	⌈⌋	⌈⌋	□
1.2m	288 ●	6	24	4	BRIN288
1.2m	288 ●	6	24	4	BRIN288W
extension cable 2m					FY04W-PVC

XLED HANGING STEMS

Double drop double-sided

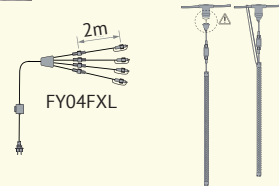
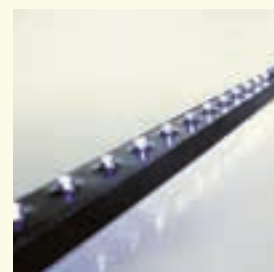

FXL08-B22

Suspension attachment and securing required during installation

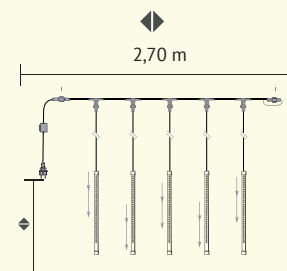

PRODUCT INFO

A smooth double-drop animation, exclusive to Blachere, a registered design that is one of the reasons behind the brand's success, notably with the Champs-Élysées project. Double-sided rods for 360-degree luminosity. Can be used for a wide range of applications, including facades, street crossings and tree decorations. Multi-output accessory FY04FXL : 20 stems on a single power supply!

◆	◀	LED	P (W)	□	☑	■
0,5m	2,7m	320 ●	12	5	2	FXL055
0,8m	2,7m	480 ●	17	5	2	FXL085

X-LED STEM FOR B22/230V SOCKET FY03B22 ACCESSORIES

◆	LED	P (W)	■
0,8m	96 ●	2	FXL08-B22
Multi ends power supply			FY04FXL



HANGING STEMS

flashes

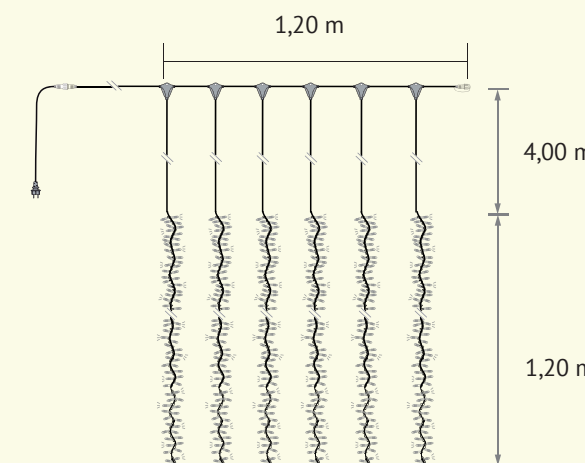

PRODUCT INFO

Very light products for hanging on all types of branches.

Pack of 6 drop decorations.

◆	◀	LED	FLASH	P (W)	□	☑	■
1,2m	1,2m	480 ●	120	50	6	3	950-FX
1,2m	1,2m	480 ●	120	50	6	3	950W-FX



HANGING LIGHTS

foldable - 230V

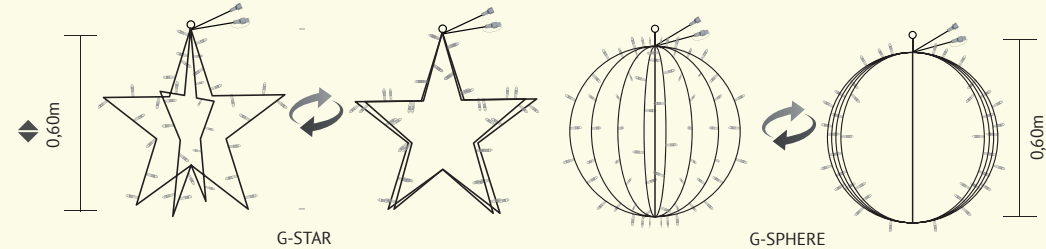
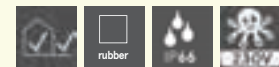

Led Classic compatible with Octopus 230V range
requires 230V power supply cable L: 1,50m FY08+ type... and bridge rectifier FY043+ type...

∅	◆	LED	FLASH	P (W)	□
0.6m	0.6m	70 ●	6 ☀	4	G-SPHERE
0.6m	0.6m	41 ●	4 ☀	4	G-STAR

HANGING LIGHTS

foldable - 24V

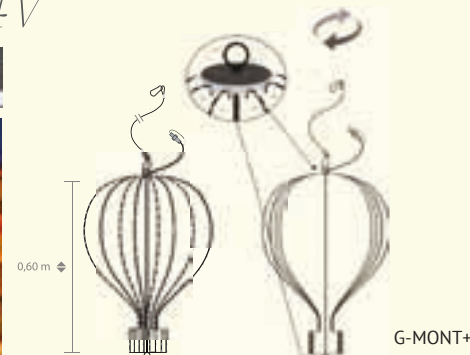

Micro light + PRO compatible with Octopus 24V range

∅	◆	LED	P (W)	□
0.6m	0.6m	136 ●	12	G-MONT+
0.6m	0.6m	136 ●	12	G-MONTW+
0.6m	0.6m	144 ●	12	G-SPHER+
0.6m	0.6m	144 ●	12	G-SPHERW+
0.6m	0.6m	88 ●	10	G-STAR+
0.6m	0.6m	88 ●	10	G-STARW+

compatible with PRTR24V or OCTOPLUS 24V accessories

PRODUCT INFO

These foldable suspensions are aesthetic by day thanks to the white lacquering of the metal structures (available in Led Classic or Micro light + PRO). Power supply sold separately.

Compatible with the entire range.

HANGING BALLS

inflatable



Using a conventional inflation gun

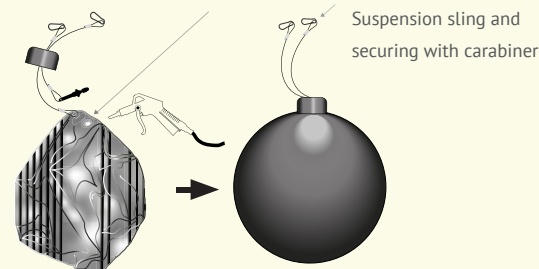

PRODUCT INFO

Passive decorative balls, ideal for decorating ceilings or trees by day or night.

Inflates on site with a simple compressor. Set of 4 balls, for outdoor use.

∅	colour	ref (set of 4)
0.5m	●	BG50-1
0.5m	●	BG50-2
0.5m	●	BG50-3
0.5m	●	BG50-4



GOBO PROJECTORS

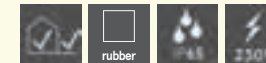

PRODUCT INFO

Rotating projector.
Multiple pattern options.
Manual control available or via DMX.

Contact us for more information.

Note: Technical specifications and the type of gobo projector are subject to change depending on the manufacturer.



BUNCH LIGHT® BOUQUETS

with RGBWW LEDs



KBRGBWW

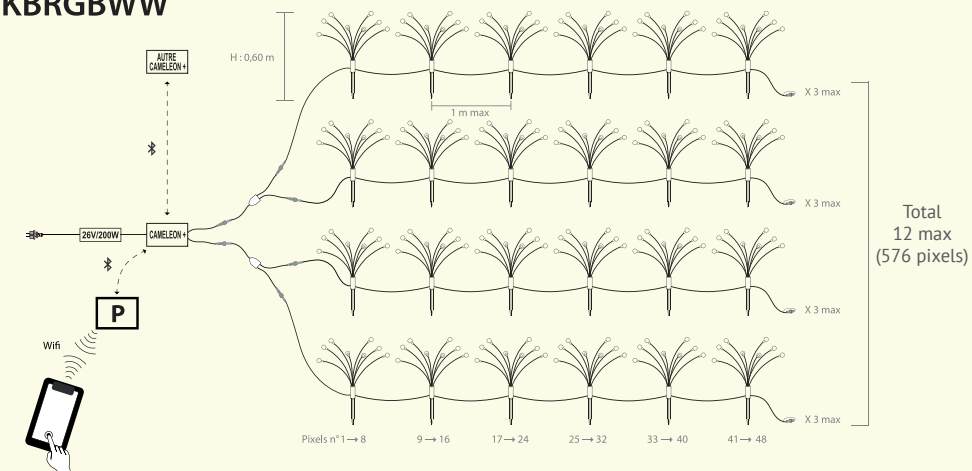

Our new Bunch Light® RGBWW Bouquets can be placed on the floor to create animated, multi-coloured lighting surfaces.

They can be custom-controlled to create an overall lighting design. Each bead can be controlled like a pixel to create a multicoloured field of light. The rods are flexible and move with the wind, creating an animated and truly magical display.

This product is sold in packs of 6 bouquets, each made up of 8 RGBWW beads.

If your project requires a customised analysis, please contact your account manager.

LED PROJECTORS

Round

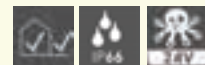

PRODUCT INFO

Light up the trunks or branches of your trees with our round micro spotlights!
Mini size but super powerful!

Bright, elegant and easy to install. Totally safe for the public (24V) and the trees (elastic ties, protective foam).

ROUND SPOTLIGHTS FOR TREES (SET OF 2)

dim.	LED	tension	P (W)	ref
180 x 55 x 24 mm	2x6 ●	24V	2 x 6W	PRJA
180 x 55 x 24 mm	2x6 ●	24V	2X6W	PRJA-W
black switch-mode power supply 24V dc 25W (for a set of 2)				PRTR24N
elastic strap for PRJA-W and PRJA projectors				FYSDOW
protective and adhesive foam (set of 10)				FY-MOUS



LED PROJECTOR

Decorative



PRODUCT INFO

Decorative spotlight, ideal for creating a soft, warm atmosphere.

LED DECORATIVE SPOTLIGHT - UNIT - IP65 - CLASS 1

LED	tension	P (W)	ref
●	230V	6	PRJP-03W+



PROJECTORS AND WALL-WASHES LED

RGBW-DMX



PRJR4-DMX

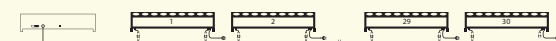

HLPRJDMX



PRJP5-DMX

RGBW WALL-WASHES



◆	LED	angle	tension	weight	P (W)	reference
1 m	16 RGBW	39°	110-240V	6,2kg	75	PRJR4-DMX
6 m	DMX extension lead					FY5P-DMX
6 m	DMX signal extension lead					FY5S-DMX

RGBW PROJECTORS



Dimensions	LED	angle	tension	weight	P (W)	reference
21 cm x 12 cm x 15 cm	6 led x 5W RGBW DMX avec mode manuel	40°	230V	2,7kg	35	HLPRJDMX
21 cm x 33 cm x 17 cm	15 RGBW	40°	230V	5,2kg	115	PRJP5-DMX

Option: controllable with infrared remote control (distance 3 to 4 m max). Simple functions.

PRODUCT INFO

Range of RGB strip lights. Perfect for facades or monument illuminations.

Use of the SMD RGB led for a better lighting result.



FILS LUMIÈRE®

static

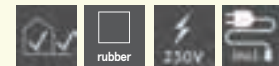

FIL LUMIERE® PLATINIUM & ECO

30 Led/m



320° inverted cone LED with vertical positioning

FIL LUMIERE® DUO COLORS

30 Led/m



FIL LUMIERE® NEON

144 Leds SMD/m



	Fil Lumière® eco	Fil Lumière® Platinum	Fil Lumière®Néon	Fil Lumière DUO COLORS®
Led density/m	30	30	144 SMD	30
P (W) /m	3,5	4	7	3,5
Roll of	90,00m	50,00m	25,00m	25,00m
ø	12mm	12mm	15mm	13mm
IP	IP55	IP66-69	IP66	IP66
□	■	■	■	□
○	NL5011	NLEDU51	NLEDN01	
●	NL5011W	NLEDU51W	NLEDN01W	
●	NL5012	NLEDU52		
●	NL5014	NLEDU54		
●	NL5016	NLEDU56		
●	NL5013	NLEDU53		
●				NLEDWW

PRODUCT INFO

Platinum fil lumière® (strand lights):

Ideal for showcasing facades. Comes with 3 special LED power supplies, 3 end caps and 3 connectors. Strictly for professional use, not for retail sale in shops.

DUO COLORS® strand light:
2 products in 1!

Your strand lights can be either warm white or pure white. Reverse the connection to get pure white or warm white.



TECHNICAL

pages

OUR STEERING SOLUTIONS

It's time to step up the smart city movement to save more energy.

Eco-designed equipment that is sustainable and smart energy management are part of any global eco-friendly urban policy. Blachere Illumination is committed to working alongside cities and developing innovative solutions to protect our planet and our future.

With our lighting management systems, you can remotely manage lighting with a single click.

Whether it's with **our range of timer boxes or our MASTER+SAVER global control system on the next page.**

This makes it easier for the city to manage its electricity resources in line with its ecological and sustainable development aspirations.



ON/OFF BOX WITH REMOTE CONTROL

When you fit your set with this remote control switch, you can install and connect your set to the public lighting system in advance and switch it on manually with the remote control on the day of the lighting show, without having to interact with the box installed on lighting set.

Box ref: TERUP

Remote control ref: TERUP-C (can control multiple TERUP boxes)

- SIMPLE **ON/OFF** CONTROL
- WORK **VIA REMOTE CONTROL**

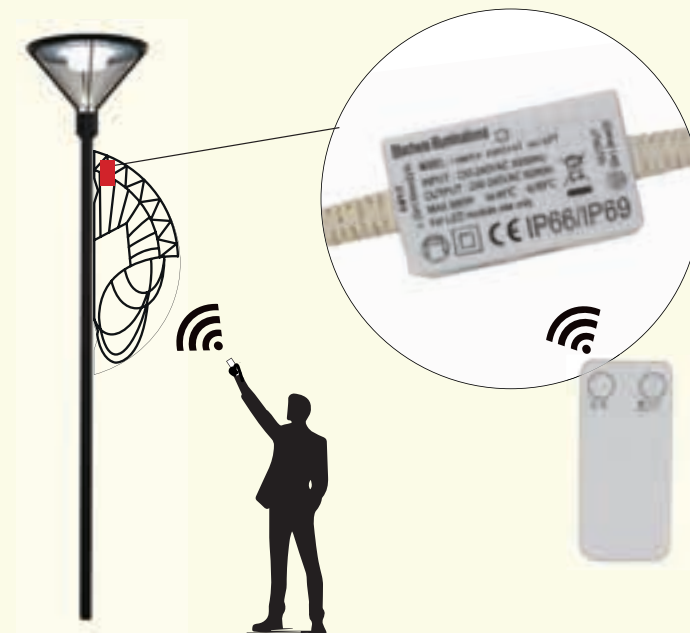

TEMPO 2 BOX UNIVERSAL & 7-HR PROGRAMMABLE

When you fit your set with the TEMPO2 box, you can disconnect it from the public lighting network. Sets are switched off automatically after 7 hours, from the moment the street lighting switched on.

By connecting a TERUP ON/OFF box upstream of this box, you can trigger the timer using the remote control.

Compatible with Octoplus **and/or any other decor.**

Box ref: **TEMPO2**

- AUTOMATIC **7-HOUR** TIME DELAY
- CONTROL IS **ON THE BOX**



TEMPO+ BOX PROGRAMMABLE FROM 5 TO 10 HRS

When you fit your set with the TEMPO+ box, you can disconnect it from the public lighting network and can adjust the lighting times you want and programme the lights to go out. A long press means you can select 5, 6, 7, 8, 9 or 10 hours of illumination followed by automatic switch-off. By connecting a TERUP ON/OFF box upstream of this box, you can trigger the timer with the remote control. Octoplus compatible.

Box ref: **TEMPO+**

- TIME DELAY SELECTABLE **BETWEEN 5 AND 10 HOURS**
- CONTROL IS **ON THE BOX**

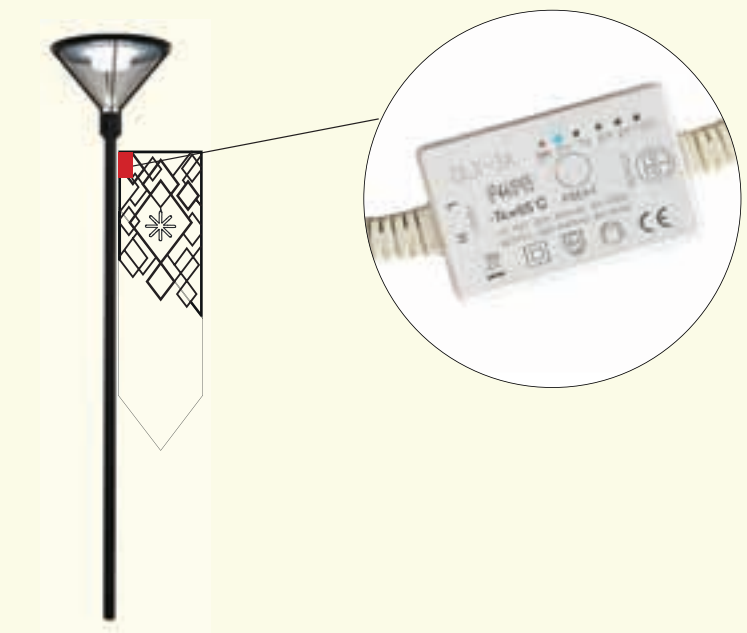

MASTER+SAVER SYSTEM

Fit your light displays with SAVER boxes. One of lighting sets will be «group leader» and will be equipped with a MASTER box. The MASTER box can be programmed with the switch-on times/days and will communicate the same information to all the SAVERS via Bluetooth.

The distance between SAVER and MASTER must not exceed 50m. If two sets are more than 50m apart, you will need to make a new group with a new MASTER box. You also need to be close to the MASTER, with your phone in your hand and the application open, to be able to control your sets.

Lighting sets can be pre-programmed in our workshops or programmed by the customer themselves using the dedicated mobile application.

- SUPER EASY CONTROL VIA **MOBILE APPLICATION**
- CREATION OF **SET GROUPS**
- PROGRAMMING OF **SWITCH-ON DAYS AND TIMES**
- MANAGEMENT OF **SWITCH-OFF TIMES FOR ENERGY SAVINGS**
- **SECURE W - DATA PROTECTION**

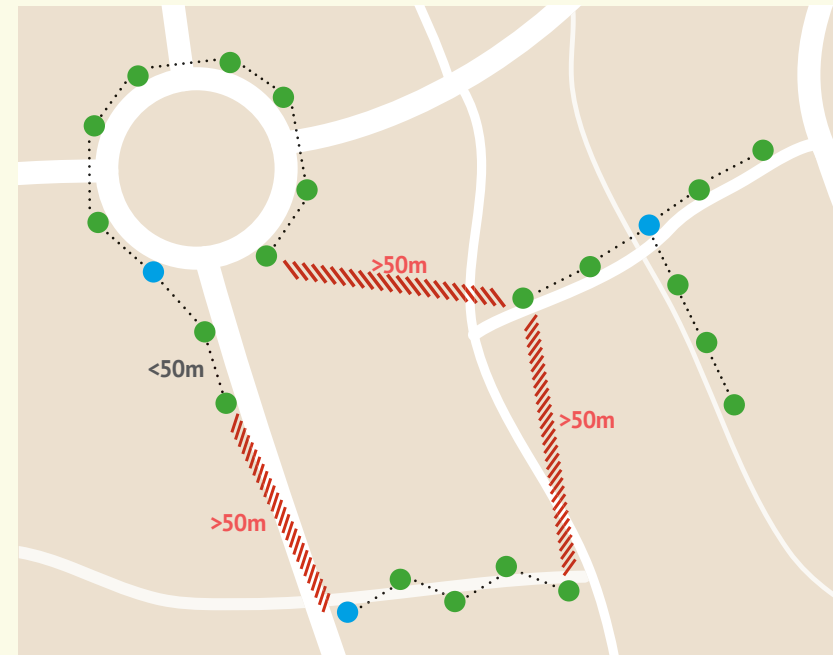

OCTOPLUS BY BLACHERE®

Exclusive



OctoPlus by Blachere® 230V connector, protection rating **IP67**, according the European standard EN60529 on the degree of protection provided by enclosures.



Safety extra-low voltage connector 12/24V



Special connector RGBWW 12V

OctoPlus is the connector that enables fast and multiple connection between our decorations and most of our range of garlands. Each item that is marked “OctoPlus” can therefore be connected to another “OctoPlus” item. This means the combination of items is infinite just by simplifying the electrical connections.

EXAMPLE FOR A TRANSVERSE MOTIF



Ref.	Quantity	Page
FY08-B+	1	263
FY043A-B+	1	263
FY01-3B+	1	263
FL390WBF+	1	207
FCL080G-E	2	231
FYPRT9B	2	265
FYT-B+	2	263

To install on steel wire with PVC sheath



EXAMPLE FOR A WIDTH OF 4,50M

Ref.	Quantity	Page
FY08-B+	1	263
FY043A-B+	1	263
FY01-2B+	1	263
354W	1	209
FYT-B+	2	263
FYPRT9	2	265
G-FL900	2	233

To install on steel wire with PVC sheath





EXAMPLE FOR A TREE

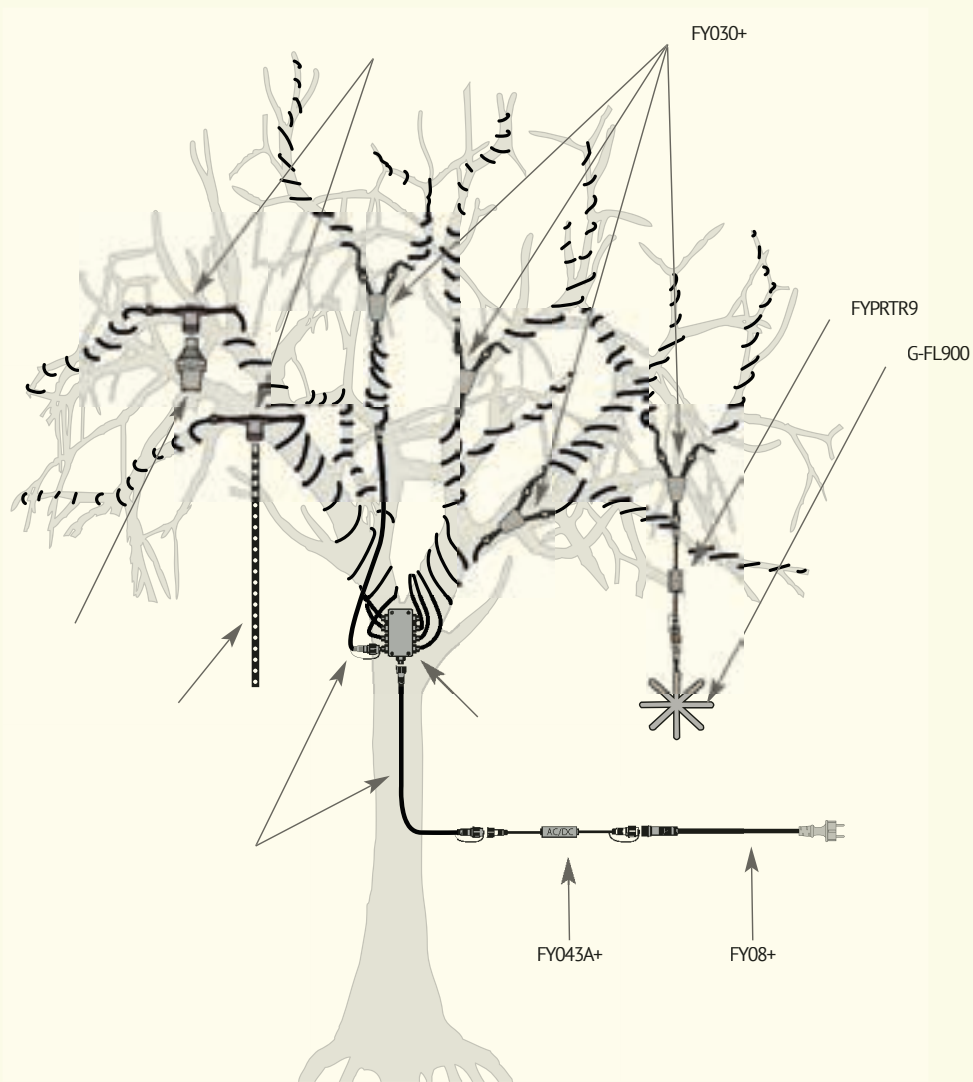

Ref.	Quantity	Page
FY08-B+	1	263
FY043A-B+	1	263
FY01-3+	2	263
BTX8	1	263
508R-FX	10	173
FY030+	4	263
FYPRTR9	1	265
G-FL900	1	233
FY03B22	1	264
FXL08-B22	1	240
F722-L	1	185

OCOTPLUS CONNEXIONS 230V - (1/2)



Diagram/Picture	Description	Obs	■	□
	Power cable 230V - 1.5m - HO5RN-F - 2x1mm ² with male plug and female Octoplus connector	Euro	FY08+	FY08-B+
		UK	FY08-UK+	FY08-BUK+
		Swiss	FY08-S+	FY08-BS+
		Wieland	FY08-W	FY08-BW
	AC/DC bridge rectifier (compulsory) for LED+ with Octoplus connector (M+F)	1A/230W	FY041A+	FY041A-B+
		3A/690W	FY043A+	FY043A-B+
	Octoplus extension 230V - HO5RN-F - 2x1mm ²	1m	FY01-1+	FY01-1B+
		2m	FY01-2+	FY01-2B+
		3m	FY01-3+	FY01-3B+
		5m	FY01-5+	FY01-5B+
		10m (2X5m)	FY01-10+	FY01-10B+
	Set of 5 end-caps plugs		FY1C+	FY1CB+
	T connector 230V (M+F/F)		FYT+	FYT-B+
	Y connector 230V (M+F/F)		FY030+	FY030-B+
	W connector 230V (M+F/F/F)		FY031+	FY031-B+
	Collector - 230V - HO5RN-F L = 2 x 1.60m = 3.20m 20cm between connectors with 16 sockets and steel wire with PVC-coating 690 W max in total		FY023+	FY023-B+

OCTOPLUS CONNEXIONS 230V - (2/2)



Diagram/Picture	Description	Obs.	■	□
	IP66 multi-socket box with 4 Octopus (F) outputs and one Octopus (M) input	690 W max	BTX4	-
	IP66 multi-socket box with 8 Octopus (F) outputs and one Octopus (M) input	690 W max	BTX8	-
	230V adaptor Sparklight and Stalactites (connector 2017 -> connector 2018)	-	FY230F2	FY230F2-B
	230V adaptor Sparklight and Stalactites (connector 2018 -> connector 2017)	-	FY230M1	FY230M1-B
	B22 bushing with M/F Octopus connector	5W max	FY03B22	FY03B22-B
	Elasticated "SPECIAL TREE" connector to let the tree grow without any restrictions	lot de 5	FY07A	.
	20cl tube of silicone sealant for full sealing of connectors (extreme environment)	-	NLC60	-
	Protective and adhesive foam	-	FY-MOUS	-

OCTOPLUS CONNEXIONS 24V



Diagram/Picture	Description	Obs.	■	□
	1m extension PVC cord 24V Connectors M-C1/F-C2		FY01-PVC	FY01B-PVC
	2m extension PVC cord 24V Connectors M-C1/F-C2		FY02-PVC	FY02B-PVC
	5m extension PVC cord 24V Connectors M-C1/F-C2		FY05-PVC	FY05B-PVC
	2 output connector PVC 24V Connectors M-C1/F-C2		FY2-PVC	FY2B-PVC
	3 output connector PVC 24V Connectors M-C1/F-C2		FY3-PVC	FY3B-PVC
	230V -> 24V transformer with Octopus connector	10W max	FYPRTR9	FYPRTR9B
	Transformer 230V / 24V with Octopus connectors	100W		PRTR100W
	collector 24V - PVC L: 80cm - 4 sockets spacing 20cm		FY024	FY024-B

OCTOPLUS TECH CONNEXIONS 12V



Diagram/Picture	Description	Obs.	■	□
	T connector Octoplus Tech	-	FT-T1	FT-T1B
	Octoplus Tech extension - 50 cm	-	FT-R05	FT-R05B
	Octoplus Tech extension - 1 m	-	FT-R1	FT-R1B
	Octoplus Tech extension - 2 m	-	FT-R2	FT-R2B
	3 outputs Octoplus Tech collector	-	FT-C3	FT-C3B
	12V/100W transformer	-	FT-TR100	-
	12V/200W transformer	-	FT-TR200	-
	End-caps plug Octoplus Tech	lot de 5	FT-B	FT-BB

FIL LUMIÈRE® ACCESSORIES

Electrical accessories for LED Platinum fil lumière® ø 12mm



NLC95-12 Fil lumière® Led power cord kit **NLC51L-12** Glueable L connector **NLC92-12** Standardized glueable central "spins" **NLC54-12** Glueable insulation end cap

The kit includes : 1 rubber power lead of 1m with plug and polarized connector + integrated AC/DC bridge rectifier, 1 power lead spin, 1 full spin, 1 pot of glue and 1 end cap.

Fixing accessories for Led fil lumière®



NLC56

X 100

NLC59

NLC61 - Pot of glue PVC 250ml

Repair kit for Led Platinum fil lumière® - 230V - IP55 - ø 12mm

For Blachere Illumination motifs only

NLKL01-12	10 m of fil lumière®	white Led		(type NML41),	2 power leads,	glue,	10 connectors,	5 end caps
NLKL02-12	10 m of fil lumière®	blue Led		(type NML42),	2 power leads,	glue,	10 connectors,	5 end caps
NLKL06-12	10 m of fil lumière®	red Led		(type NML46),	2 power leads,	glue,	10 connectors,	5 end caps
NLKL01W12	10 m of fil lumière®	warm white Led		(type NML41W),	2 power leads,	glue,	10 connectors,	5 end caps

FIXING ACCESSORIES FOR MOTIFS AND CONNECTION HOUSING

Photo	Infos	Ref	Photo	Infos	Ref
	Heart shape eye for ø 4mm cable set of 10	D001		Transverse unit for fastening to pole for ø 11mm cable pair	MA011
	Heart shape eye for ø 6mm cable set of 10	D011			
	Cable gripper for ø 4mm cable set of 10	D002		Eyebolt L : 150mm set of 2pcs	D033
	Cable gripper for ø 6mm cable set of 10	D012			
	Steel cable ø 4mm 100m roll	D005		Galvanized steel shackle ø 10mm	MA002
	Steel cable ø 6mm 100m roll	D006			
	Steel cable ø 4mm with PVC sheath ø 6mm 100m roll	D015		Mixed stretcher unit - M10 L : 22 to 30cm	D004
	Steel cable ø 6mm with PVC sheath ø 8mm 100m roll	D016		ø 6mm Snap hook WLL 80kg	DOM7T
				safety sling L : 60cm WLL : 70kg	D026
				Differential circuit-breaker equipped with a waterproof power plug. (for poles) Note : box subject to modification according to availability	C001

FIXING ACCESSORIES FOR POLEMOUNTS



Inverted cone
1 PIX03 (up)
1 PIX04-2 (down)
2 curtains H : 5m

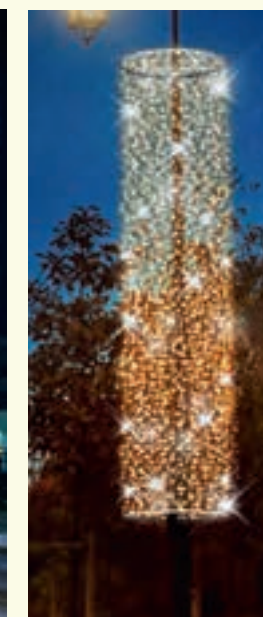

Cylinder
2 PIX03
2 curtains H : 5m



Christmas tree
1 PIX04-2 (up)
1 PIX02 (down)
1 curtain H : 3m

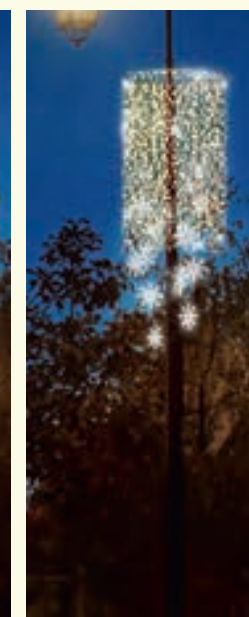

Free composition
2 PIX03
2 FL74WBF+
1 FL900E

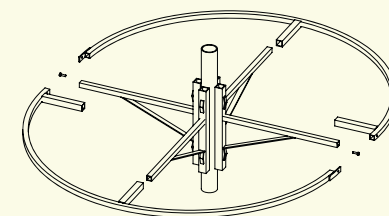

PIX02 / PIX03



PIX04-2

Circular brackets
Put together low-price 3D decorations
on your columns with our circular brackets
(inner diameter adjustable)

Ref	ø	Perimeter	pole ø	usable with
PIX04-2	25 cm	0,80 m	60 à 120 mm	curtains
PIX02	60 cm	1,90 m	60 à 200 mm	
PIX03	130 cm	4,00 m	60 à 200 mm	

FIXING ACCESSORIES FOR POLEMOUNTS

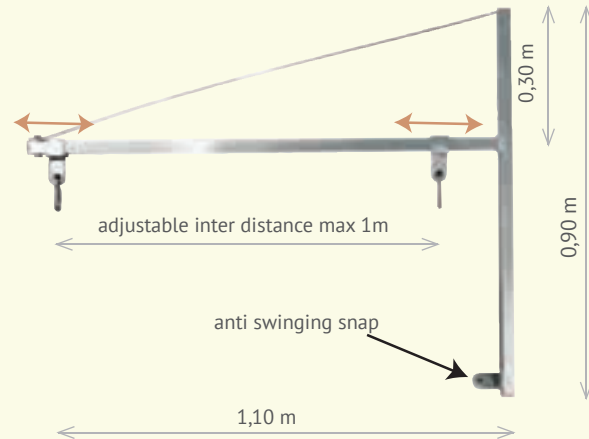

PIX01
Horizontal bracket
H:0,90 m - L: 1,10 m
inter distance max: 1,00 m
max load: 25 kg

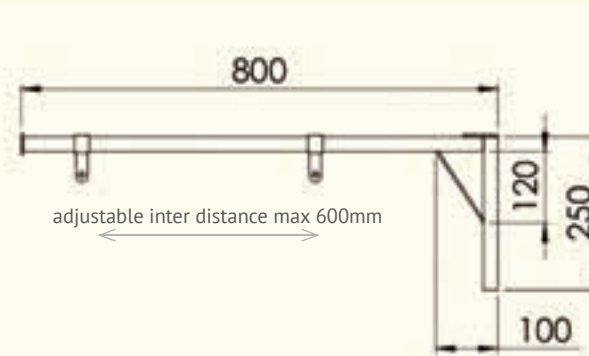

PIXECO
Horizontal bracket
H : 0,25m - L : 0,80m
max load : 10kg

FIXING ACCESSORIES FOR POLEMOUNTS

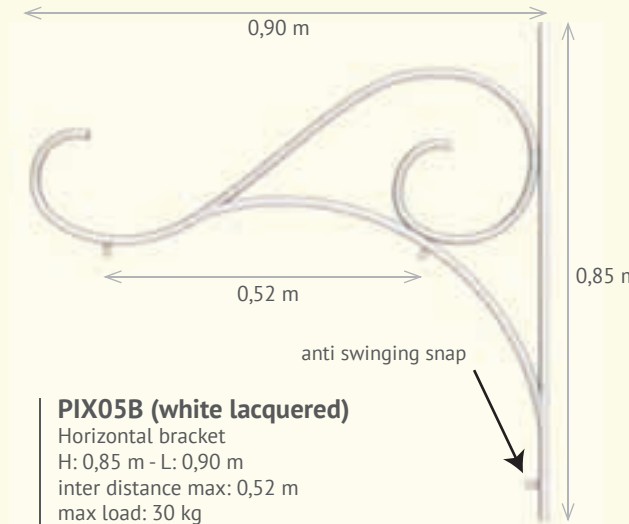

PIX05B (white lacquered)
Horizontal bracket
H: 0,85 m - L: 0,90 m
inter distance max: 0,52 m
max load: 30 kg

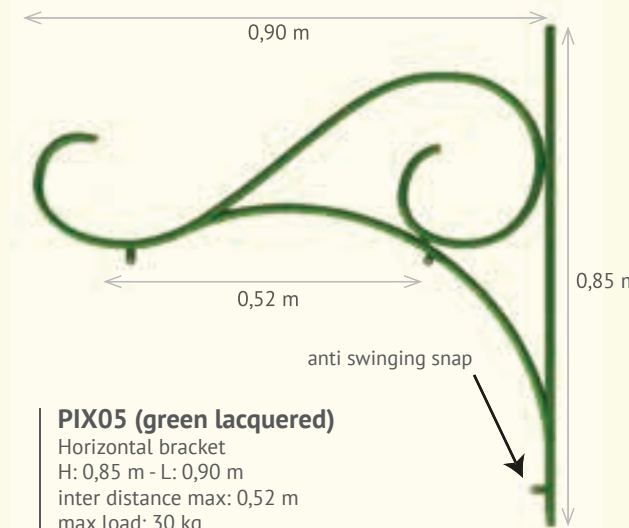

PIX05 (green lacquered)
Horizontal bracket
H: 0,85 m - L: 0,90 m
inter distance max: 0,52 m
max load: 30 kg

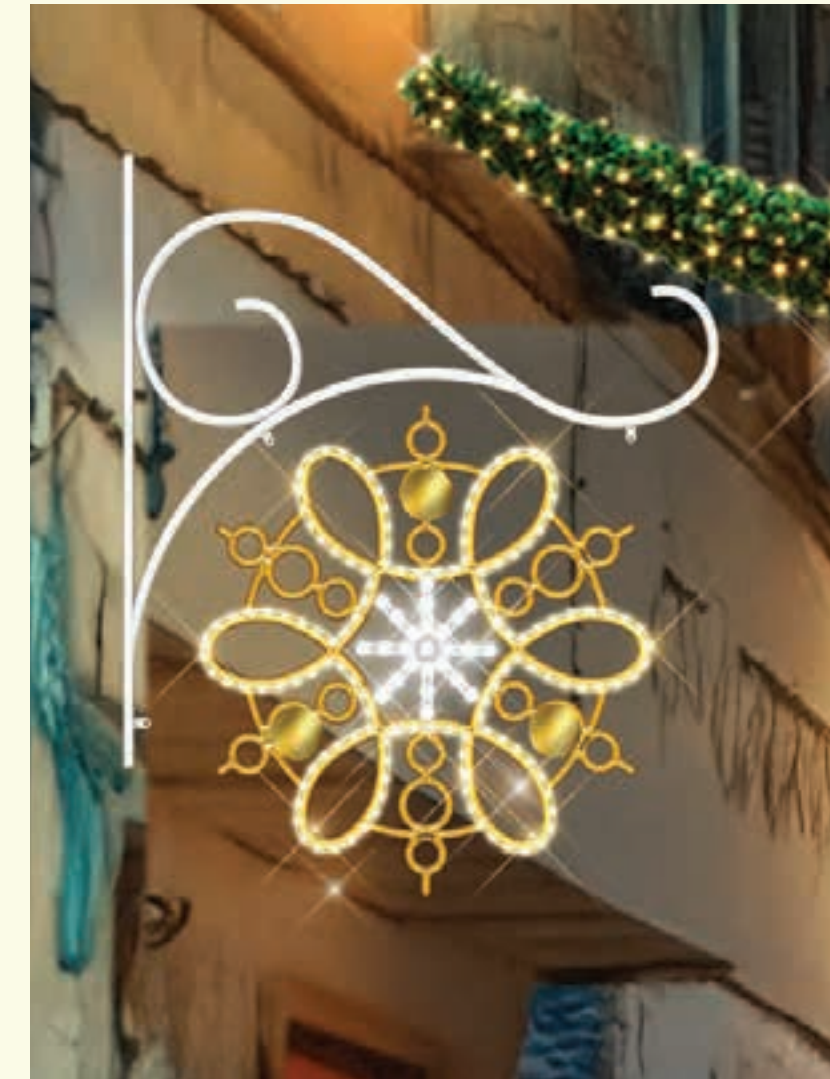

FIXING ACCESSORIES FOR MOTIFS

"Order your FIX01 fixing to colour match your lamp columns!!!
Let us know the corresponding RAL and get a customized quotation. Contact our sales department for information"

FIX01 (pair)
Fastening device for pole



FIX01P (pair)
Strengthened fastening devices for poles (storm conditions)
(wind area 3)

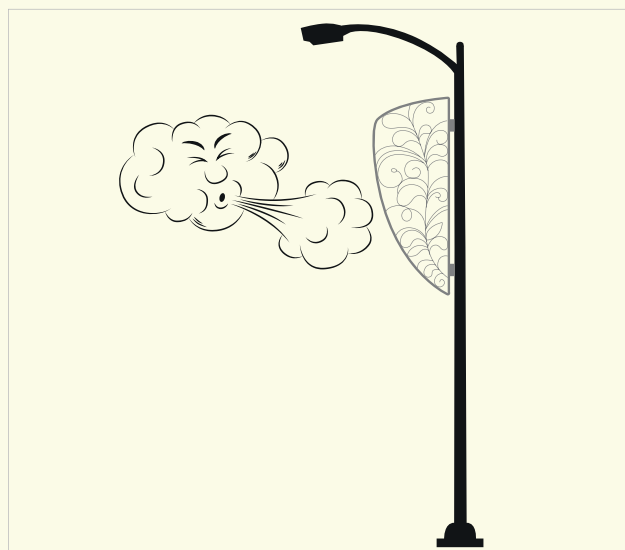
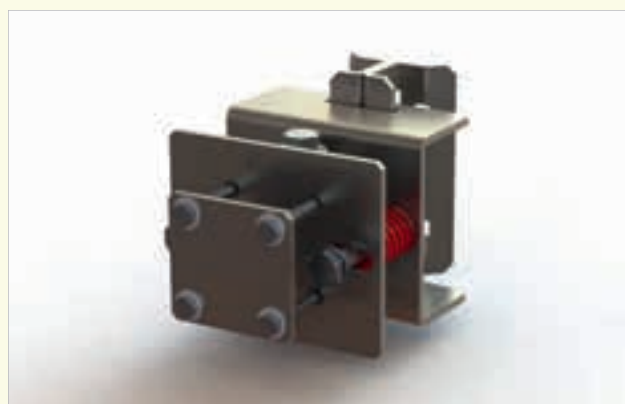

"Order your FIX01 fixing to colour match your lamp columns!!!
Let us know the corresponding RAL and get a customised quotation. Contact our sales department for information"

FIX01M (pair)
Fastening devices for facades

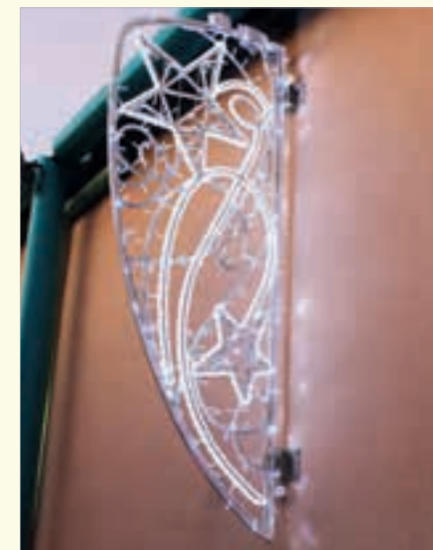

FIX01MC (pair)
Fastening devices for curved pole

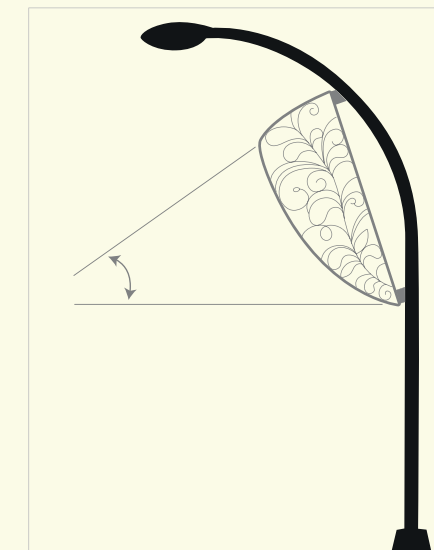

Each fastening must be individually strapped twice (see diagram). For motifs exceeding a height of 3.5m, it is essential to use three fasteners per motif.

D007 : Stapping box including 1 cutting pliers and 1 stapping pliers.

D008 : Stainless steel strap
Roll of 50m, thick-ness : 0,7mm

D009 : Staple-clip for steel strapset of 100

D010 : Black protection strip for Stainless steel strap - L: 10 ml / 10 mm



D008



D007

D010

D009



FYS060N
Fixing of decorations on masts.

Black strap: l: 15mm, L: 600mm,
8cm mini ratchet, LC 50 daN

This strap is reusable and does not slip

SOLAR ACCESSORIES

A new roundabout to decorate but no power supply?

Or looking to illuminate a street on your own with zero carbon emissions?

Choose our solar solutions.

Discreet panels, with an integrated autonomous and programmable system (switch-on and switch-off times).

Adapted light decorations, 24V garlands, and more. We offer you a **complete range that is 100% self-powered.**

All you need is sunshine!

Consult our advisory teams for a personalised analysis



SOLAR KIT SELF-POWERED

KITSOL

- Kit containing a solar panel with high-performance monocrystalline cells.
- Gel batteries for 2400 cycles with discharge..
- Power regulator and discharge protection.
- 24V or 230V output easily switched by rotary selector.
- Can be fixed to the floor.

PRODUCT INFO

- 50% battery consumption after 12 hours.
- Low-power prevents battery damage.
- Easy to move thanks to flexible rubber wheels with high abrasion resistance.
- Maintenance-free and easy to install.



SOLAR KIT POLE

PIXSOL2

- 20W panel power
- 7.2W power output
- DAILY PROGRAMMER: selection of the days and times lighting set is switched on
- 8 to 10 hours of sunshine required for 7 hours of lighting set operation

COMPATIBLE PRODUCTS

- | | |
|----------------------|-------------------------|
| Garland 1 x FL502@ | Sphere 1 x G-FL920M |
| Garland 1 x 501CW | Bulb 1 x G-FL930BB |
| Garland 1 x 501W | Kit 1 x PRJA and PRJA-W |
| Sphere 1 x G-FL920LU | |



SOLAR KIT POLE

PIXSOL3

- 12W panel power
- 4W power output
- DAILY PROGRAMMER: selection of the days and times lighting set is switched on
- 8 to 10 hours of sunshine required for 7 hours of projector operation



RÉFÉRENCES COMPATIBLES

½ PRJA/PRJA-W



SCENOGRAPHY/DECORATION ACCESSORIES

Pictures	Infos	Ref
	To complement your decorations, we can provide you with our real firtrees sustainably cultivated and processed with flake finish based on fireproof natural cellulose fibre. Contact our sales department and choose your colours and finish.	
	Mounting base lacquered in gold for 3D motif ø : 800mm	PLA800OR
	Mounting base lacquered in gold for 3D motif ø : 1200mm	PLA1200OR

Picture	Infos	Ref
		
	Opera barrier H : 1,20m L : 2,00m	BARR01
	White pine barrier H : 0,80m L : 1,80m	GP506-B

SCENOGRAPHY/DECORATION ACCESSORIES

Picture	Infos	Ref
	Square Carpet Blue 3m x 3m	GPC300B
	Round Carpet Blue ø : 3m	GPR300B
	Square Carpet Red 3m x 3m	GPC300R
	Round Carpet Red ø : 3m	GPR300R

Picture	Infos	Ref
	White cotton carpet roll 30m x 2,6m	GP500
	Red carpet roll 10m x 2m	GP510R
	Red - ø 140mm Set of 16	B14-1
	Gold - ø 140mm Set of 16	B14-2
	Red - ø 200mm Set of 9	B20-1
	Gold - ø 200mm Set of 9	B20-2
	Red - ø 280mm Set of 2	B28-1
	Gold - ø 280mm Set of 2	B28-2

BALLASTING ILLUMINATIONS

Dress up your blocks as pretty gifts!

Use our magical gifts to hide the concrete blocks in your decorations!

Depending on the features of your decoration, put together your own ballast kit and wrap your gift (size & colour).

Wrapping steps (clips are supplied)



Example : KPLO100B + KFLEXCA1



1. Choose your block

Reference	Description	dimensions
KPLO100B	Concrete block - 100kg	0,37 x 0,37 x 0,37m
KPLO040	Concrete block - 40kg	0,30 x 0,30 x 0,20m
KPLO020	Concrete block - 20kg	0,20 x 0,20 x 0,20m

2. Choose your cover

Reference	Description	dimensions	colour
KFLEXCA2	Block cover - PM	0,2 x 0,2 x 0,2m	blue / white
KFLEXCA5	Block cover - MM	0,3 x 0,3 x 0,2m	blue / white
KFLEXCA8	Block cover - GM	0,37 x 0,37 x 0,37m	blue / white
KFLEXCA1	Block cover - PM	0,2 x 0,2 x 0,2m	red / white
KFLEXCA4	Block cover - MM	0,3 x 0,3 x 0,2m	red / white
KFLEXCA7	Block cover - GM	0,37 x 0,37 x 0,37m	red / white
KFLEXCA3	Block cover - PM	0,2 x 0,2 x 0,2m	green / white
KFLEXCA6	Block cover - MM	0,3 x 0,3 x 0,2m	green / white
KFLEXCA9	Block cover - GM	0,37 x 0,37 x 0,37m	green / white

Enter the reference for the decoration + the block + the cover

GX345L +
 . 3 x KPLO100B + 3 x KFLEXCA8 +
 . 3 x KPLO040 + 3 x KFLEXCA6



INDEX



ARTOT02	146
CIME2	71
CIME4	71
CIME6	71
CIME7	71
GX047L	36
GX048LW	118
GX070CL	42
GX070LR	41
GX079L	33
GX081LW-2	68
GX082LW	68
GX083LW	68
GX086L	32
GX086L-A	32
GX087L	21
GX092L	24
GX093L	24
GX097L	33
GX098L	33
GX102LW	28

GX103L	36
GX103L-A	36
GX105L	31
GX107	157
GX107-UK	157
GX108	157
GX108-UK	157
GX110	157
GX110-UK	157
GX114LW	90
GX116LW	108
GX117LW	108
GX118DC	27
GX118L	31
GX119L	31
GX132L	23
GX133L	32
GX145L	37
GX145L-A	37
GX146L	147
GX147L	37

GX148L	22
GX149L	37
GX151L	26
GX152L	26
GX153L	23
GX154LW	41
GX155LW	40
GX156LW	48
GX159L	30
GX160L	36
GX163L	21
GX164L	31
GX168LW	48
GX171RGBW	43
GX172LW	34
GX173L	50
GX173LW	50
GX182L	36
GX182L-A	36
GX184L	38
GX184LW	38

GX185LW	51
GX193L	29
GX194L	27
GX200L	147
GX205L	37
GX206L	37
GX210LW	48
GX242L	151
GX243LW	151
GX244L	29
GX245LW	35
GX247L-A	29
GX248LR	30
GX249L	31
GX249L-A	31
GX251L	61
GX251LW	61
GX252L	39
GX252LW	39
GX253LW	61
GX256LW	34
GX257LW	34
GX258L	35
GX258LW	35
GX259LW	35
GX260L	25
GX260LW	25

GX261LW	24
GX262LW	30
GX263L	28
GX264LW	29
GX265LW	21
GX266DC	53
GX267LW	28
GX308L	22
GX327L	48
GX327LW	48
GX333L	20
GX344L	18
GX344LW	55
GX345L	19
GX346L	16
GX347L	18
GX348L	17
GX349L	18
GX350LW	59
GX354L	52
GX354LW	16
GX355LW	53
GX356L	16
GX357L	19
GX358L	28
IPL031W	88
IPL039	104

IPL039W	104
IPL042W	138
IPL070B	112
IPL070W	112
IPL072W	126
IPL075B	94
IPL075W	94
IPL076	112
IPL076W	112
IPL081W	112
IPL082W	88
IPL084	126
IPL087W	102
IPL094W	138
IPL110	94
IPL110W	94
IPL114W	108
IPL115W	102
IPL117W	138
IPL118W	126
IPL122	128
IPL126	128
IPL126W	128
IPL127	122
IPL127W	122
IPL128	122
IPL128W	122

IPL129	80
IPL129W	78
IPL130	80
IPL130W	78
IPL131	80
IPL131W	78
IPL134W	108
IPL135	94
IPL135W	94
IPL139W	108
IPL140W	108
IPL141W	104
IPL143	80
IPL143W	78
IPL144	80
IPL144W	78
IPL145W	104
IPL150	128
IPL151W	104
IPL160	128
IPL189B	136
IPL189R	136
IPL189W	136
IPL190B	136
IPL190R	136
IPL190W	136
IPL191B	134

IPL191R	134
IPL191W	134
IPL199	124
IPL199W	124
IPL200	124
IPL200W	124
IPL201	124
IPL201W	124
IPL202W	86
IPL203W	86
IPL226W	86
IPL228B	138
IPL228W	138
IPL230	80
IPL230W	78
IPL231W	86
IPL257	132
IPL257B	132
IPL257W	132
IPL258	132
IPL258B	132
IPL258W	132
IPL259	134
IPL259W	134
IPL260W	134
IPL265W	88
IPL266W	88

IPL267W	88
IPL268W	88
IPL270R	110
IPL270W	110
IPL271R	110
IPL271W	110
IPL272	104
IPL272W	102
IPL282DC	143
IPL283DC	143
IPL284DC	143
IPL285DC	143
IPL286DC	143
IPL300B	92
IPL300W	92
IPL311	92
IPL311W	92
IPL317R	86
IPL318R	86
IPL319R	86
IPL320R	86
IPL322	122
IPL323W	122
IPL324W	102
IPL325W	102
IPL326W	102
IPL328W	98

IPL329W	98
IPL330W	98
IPL332W	98
IPL333W	98
IPL334W	98
IPL335	76
IPL335W	76
IPL336	76
IPL336W	76
IPL337	76
IPL337W	76
IPL340W	138
IPS264W	145
IPS280	145
IPS280W	145
IPS281W	145
IPS289W	145
IPS290	145
ITGL100	90
ITGL101W	90
ITGL102	116
ITGL102W	116
ITGL104	114
ITGL104W	114
ITGL105	114
ITGL105W	114
ITGL111	116

ITGL111W	116
ITGL112	140
ITGL112W	140
ITGL117R	116
ITGL130W	118
ITGL131	116
ITGL131W	116
ITGL141	116
ITGL170B	90
ITGL170L	90
ITGL179BW	100
ITGL179WW	100
ITGL180BW	100
ITGL180WW	100
ITGL182BW	100
ITGL182WW	100
ITL009	112
ITL020B	140
ITL020W	140
ITL021	94
ITL022	82
ITL022W	82
ITL033W	102
ITL043W	138
ITL053	114
ITL053W	114
ITL059W	122

ITL061	112
ITL072W	126
ITL076W	112
ITL077W	88
ITL082W	138
ITL083W	138
ITL094W	136
ITL101	82
ITL101W	82
ITL102	82
ITL102W	82
ITL113W	108
ITL115	140
ITL115W	140
ITL118W	126
ITL126	128
ITL127	122
ITL127W	122
ITL129	80
ITL129W	78
ITL130	80
ITL130W	78
ITL132W	138
ITL135	94
ITL135W	94
ITL160	128
ITL161	80

ITL161W	78
ITL163	82
ITL165W	88
ITL167	128
ITL191B	136
ITL191W	136
ITL218W	86
ITL226W	86
ITL227B	134
ITL227W	134
ITL232W	122
ITL233	82
ITL234W	134
ITL261	132
ITL261B	132
ITL261W	132
ITL262	132
ITL262B	132
ITL262W	132
ITL266W	88
ITL275R	110
ITL276R	110
ITL276W	110
ITL277W	110
ITL278W	110
ITL279R	110
ITL279W	110

ITL282DC	143
ITL288DC	143
ITL291	80
ITL291W	78
ITL310	92
ITL310W	92
ITL312	124
ITL312W	124
ITL314	124
ITL314W	124
ITL315	82
ITL316W	82
ITL317W	104
ITL321R	86
ITL327W	102
ITL328W	98
ITL331W	98
ITL332W	98
ITL333W	98
ITL338	76
ITL338W	76
KFLEXCA1	279
KFLEXCA3	279
KFLEXCA4	279
KFLEXCA5	279
KFLEXCA6	279
KFLEXCA7	279

KFLEXCA8	279
KFLEXCA9	279
KIT1-134	151
KIT1-242	151
KIT2-134	151
KIT2-242	151
KLFEXCA2	279
ML019W	104
ML020W	104
PIX05B	126
PL250B	126
PL250W	126
PL344	108
PL344W	108
SL005	51
SL005W	50
SL012	49
SL012W	49
SL013	49
SL013W	49
SL019CL	42
SL032	49
SL032W	49
SL033	49
SL033W	49
SL035W	44
SL036	46

SL036W	46
SL037W	47
SL038W	23
SL039W	51
SL040	45
SL041W	54
SL044W	45
SL045V	33
SL048	54
SL049W	54
SL050R	40
SL051W	17
SL052W	19
SL053W	16
SL134	151
SL135W	32
SL136	39
SL136W	39
SLED010W	56
SND017	56
SND018	65
SND019	63
SND021	64
SND022	63
SOCL42	36
SOCL43	25
SOCL47	26

SOCLGX81	71
SOCLGX82	71
SOCLGX83	71
SV1001	62
SV1001W	62
SV1201-P	62
SV1201W-P	62
SV301	62
SV301W	62
SV302	59
SV302W	58
SV303	58
SV303W	58
SV501	62
SV501W	62
SV502	59
SV502W	56
SV504A	22
SV505CL	64
SV506RGBW	64
SV507W	63
SV801-P	62
SV801W-P	62
TGL139W	126
TGL169LW	90
TGL247LW	118
TGL70LW	114

TGL70LWW	114
TGL71LW	114
TGL71LWCL	114
TGL71LWW	114
TGL72LW	114
TGL72LWW	114
TL311R	104
TL311W	104
TL312R	104
TL312W	104
TL347W	118
VL045W	112
VL046	128
VL045W	112
VL046	128

Blachere INTERNATIONAL



BLACHERE ILLUMINATION S.A.S

22 Allée des Bourguignons
84400 Apt - France
tél : +33 (0) 413 068 002
fax : +33 (0) 490 747 367
sales@blachere-illumination.com
blachere-illumination.com

Géraldine

tél : +33 (0) 490 747 323
geraldine@blachere-illumination.com

Léa

tél : +33 (0) 490 747 642
lalves@blachere-illumination.com

Marion

tél : +33 (0) 490 747 330
marion@blachere-illumination.com

Irène

tél : +33 (0) 490 747 396
i.baravet@blachere-illumination.com

Marie

tél : +33 (0) 490 747 044
marie@blachere-illumination.com

Cathy

tél : +33 (0) 490 747 325
cathy@blachere-illumination.com

AFRIQUE/AFRICA

Blachere Illumination Afrique
Rue du Caire - Route de M'Saken, 4081 Zaouiet
Sousse
tel : +216 73 386 601
email : gregory.roux@blachere-factory.com
fax : +216 73 386 650

ASIE PACIFIQUE/ASIA PACIFIC

Blachere Illumination Asia Pacific
Unit B, 17/F., United Centre, 95 Queensway,
Admiralty, Hong Kong
email : hkoffice@blachere-illumination.com

AUTRICHE/AUSTRIA & ALLEMAGNE/GERMANY

Blachere Illumination GmbH
Krenglbacher Straße 7- 4631 Krenglbach
tel : +43 (0) 7249 46400 - 0
email : office@blachere.at

BELGIQUE/BELGIUM

Blachere Illumination Belgique
Rue de Hermée 225, 4040 Herstal
tel : +32 4 275 02 81
email : info@blachere-illumination.be

BRÉSIL/BRASIL

Blachere Iluminação Brasil
Estrada Antiga de Itu, 1111 CEP: 06695-570,
Itapevi - São Paulo
tel : +55 11 94772-7571
email : milena.damasio@blachere-illumination.com.br

CANADA/CANADA

Blachere Illumination Canada
3400 14th Avenue, Unit 18, Markham, Ontario L3R
0H7
tel : 905-475-6553
email : info@blachere-illumination.ca
Web : www.blachere-illumination.ca

COLOMBIE/COLOMBIA

Blachere - City Lights
Carrera 33 N. 19-26, Bogotá
tel : 576 016 466 000
email : comercial@blachere.co - jklahr@blachere.co

CROATIE/CROATIA

Blachere Illumination Croatia (Blachere Illumination
- Gospodari svjetla)
Medsave 4B, 10430 Samobor
tel : +385 1 8877 660
email : info@gospodarisvjetla.hr
Web : www.gospodarisvjetla.hr

DANEMARK/DENMARK

Blachere Illumination - JADA GROUP APS
Norgesvej 2, 6230 Rødekro
tel : +45 70 20 00 03
email : info@jadagroup.dk

ESPAGNE/SPAIN

Blachere Iluminación España s.a
Calle Corazón de María, 70-8E, 28002 Madrid
tel : +34 91 388 28 77
email : info@blachere-illumination.es

ÉTATS-UNIS/USA

Blachere Illumination USA Inc.
PO Box 41, 4198 State Highway 14 W, Christopher, IL 62822
tel : +1 618-724-1500
email : info@blachere-illumination.us
fax : +1 618-724-4500
Web : https://blachere-illumination.com/en/blachere-illumination-usa

EUROPE CENTRALE/CENTRAL EUROPE

Blachere Illumination Central Europe
Karadžičova 8/A, Bratislava 821 08
tel : 421918428040
email : info@blachere-illumination.sk

FINLANDE/FINLAND

Blachere Illumination Finland - Lohikari
Ruoholahdenkatu 24, 00180 Helsinki
tel : +358 9 565 7750
email : lohikari@lohikari.fi
fax :
Web : www.lohikari.fi

HONGRIE/HUNGARY

Blachere Illumination Hungary
H-2142, Nagytarcsa, Csonka János út 4, K bâtiment
tel : +36 70 389 1475
email : info@blachere-illumination.hu

ITALIE/ITALY

Blachere Illumination Italia - Lumiworks Srl
Via Euippa 22, 73100 Lecce
tel : 393760563212
email : info@lumiworks.it

MEXIQUE/MEXICO

Blachere Iluminación México
3 Oriente No. 416 Centro. 74200 Atlixco, Puebla
tel : +52 244 44 51 281
email : contacto@blachere.com.mx
Web : https://blachere.com.mx/

MOYENT-ORIENT/MIDDLE EAST

Blachere Illumination Middle East
FAB Property Management Buildings
Building 22 Warehouse 3 DIP 1
tel : +971 4 254 8856
email : m.soltay@blachere-illumination.ae

NORVÈGE/NORWAY

Blachere Illumination Norway - Eurosign
Stanseveien 21, 0975 Oslo
tel : +47 23 00 85 00
email : salg@eurosign.no

PAYS-BAS/NETHERLANDS

Blachere Illumination Netherlands - Avontuur
Blokdijk 3 - 1608 HH Wijdenes
tel : +31 229 50 12 22
email : info@avontuur.net

POLOGNE/POLAND

Blachere Illumination Polska
Jasna 39 - 86-070 Czemlewo
tel : 48668318492
email : info@blachere-illumination.pl

PORTUGAL/PORTUGAL

Blachere illumination - Design Studio
Rua Pedro Nunes
IPN Aceleradora Edifício D - Sala 1.15
3030-199 Coimbra, Portugal
design@blachere-illumination.pt
Tel: 00351 239 134 384

RÉP. TCHÈQUE/CZECH REPUBLIC

Blachere Illumination Czech Republic
Ostrá Horka I/511 - 760 01 Zlín
tel : 420602227226
email : pesek@blachere-illuminations.cz

ROUMANIE/ROMANIA

Blachere Illumination Romania
Cluj Napoca, Str. Anatole France, nr. 22, et. 2
birou 2, Judetul Cluj, cod postal 400463
tel : +40 75 705 08 66
email : office@blachere-illumination.ro
fax : +40 31 845 13 73

ROYAUME-UNI/UK

Blachere Illumination UK Ltd
Gladstone Place, Ladybank, Fife, KY15 7LB
tel : +44 (0)1337 832 910
email : sales@blachere-illumination.co.uk
Web : www.blachere-illumination.co.uk

SUÈDE/SWEDEN

Blachere Illumination Sweden
Gustavslundsvägen 143, 167 51 Bromma
tel : +46 (0)72 601 66 46
email : info@blachere-illumination.se

SUISSE/SWITZERLAND

Blachere Illumination Swiss SA
Rue du Châtelard 18 1400 Yverdon-les-Bains
tel : 021 886 00 90
email : office@blachere-illumination.ch
Web : www.blachere-illumination.ch

TURQUIE/TURKEY

Blachere Illumination Aydınlatma
Hasanpaşa Mh. Lavanta Sk. Polat İs Merk.26/3,
Kadıköy-Istanbul
tel : +90 532 660 69 23
email : msoltay@blachere-illumination.com.tr

Blachere FRANCE

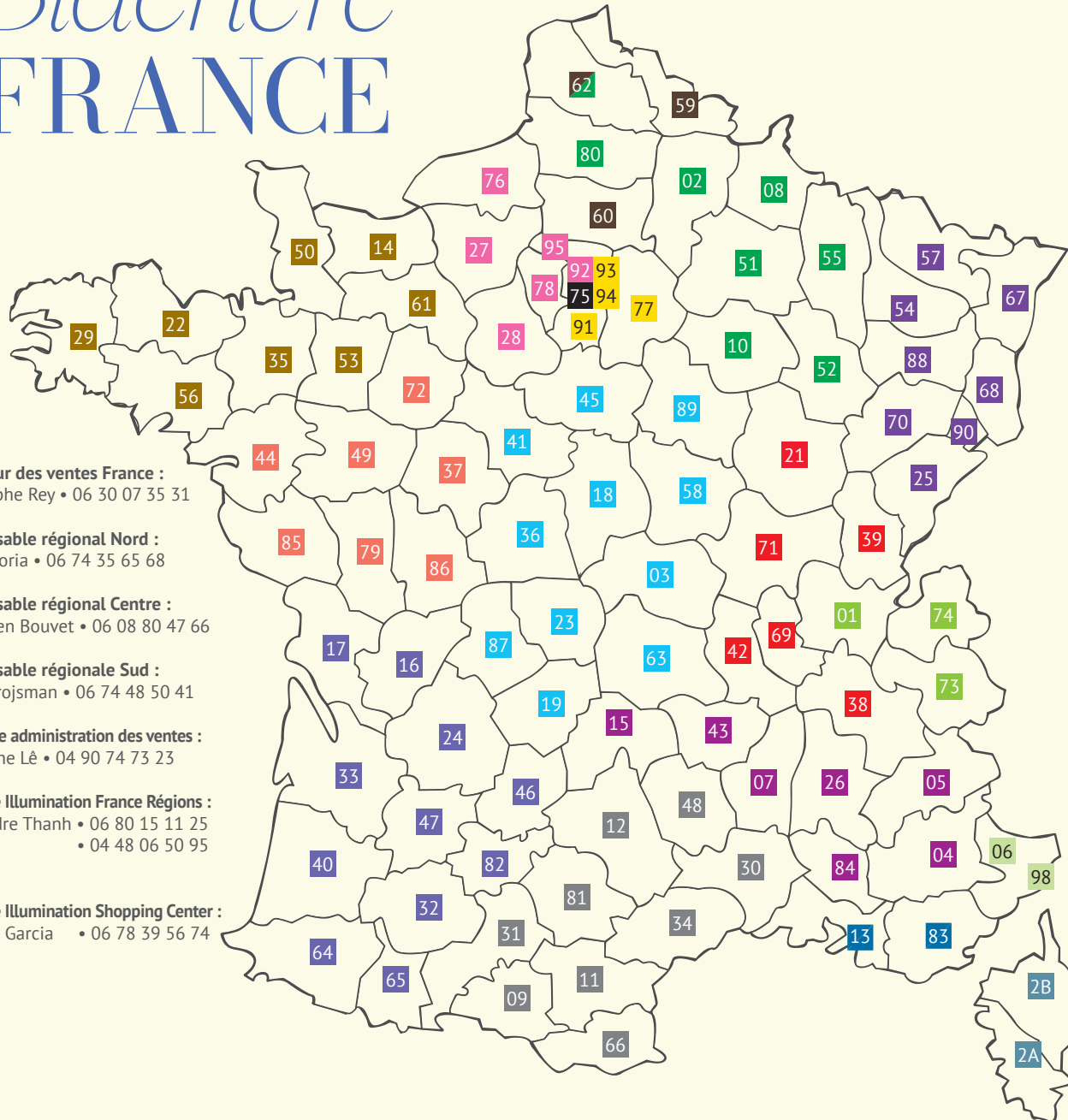

- **Directeur des ventes France :**
Christophe Rey • 06 30 07 35 31
- **Responsable régional Nord :**
Joao Vitoria • 06 74 35 65 68
- **Responsable régional Centre :**
Sébastien Bouvet • 06 08 80 47 66
- **Responsable régionale Sud :**
Aude Grojsman • 06 74 48 50 41
- **Directrice administration des ventes :**
Géraldine Lê • 04 90 74 73 23
- **Blachere Illumination France Régions :**
Alexandre Thanh • 06 80 15 11 25
• 04 48 06 50 95
- **Blachere Illumination Shopping Center :**
Corinne Garcia • 06 78 39 56 74

- Paris intramuros**
Cédric Parcineau • 01 42 77 66 15 / 07 77 26 37 76
Assistante, Sandrine Sarrazin • 04 90 74 70 45
- Île-de-France Est**
Sophie Duquesnoy • 06 08 00 57 52
Assistante, Sarah Galizzi • 04 90 74 73 61
- Île-de-France Ouest**
Véronique René • 06 08 80 47 65
Assistante, Sarah Galizzi • 04 90 74 73 61
- Nord - Picardie**
Barbara Gheysens • 06 31 59 64 07
Assistante, Anaïs Truphémus • 04 90 74 73 94
- Champagne - Ardennes**
Matthieu Mairie • 06 79 47 06 26
Assistante, Anaïs Truphémus • 04 90 74 73 94
- Alsace - Lorraine**
Olivier Radreaux • 06 07 67 39 46
Assistant, Vincent Vicari • 04 90 74 70 47
- Savoie - Haute Savoie**
Maëva Rigoureux • 06 42 56 43 70
Assistante, Stéphanie Imbert • 04 90 74 96 22
- Rhône - Sud Bourgogne - Jura - Isère - Loire**
Soizic De Vanel • 06 70 12 41 62
Assistante, Delphine Borel • 04 90 74 96 24
- Bourgogne - Centre - Limousin - Auvergne**
Maxime Bavouzet • 06 78 52 33 82
Assistante, Marianne Fabi • 04 90 74 73 90
- Bouches-du-Rhône - Var**
Xavier Le Penven • 06 84 02 80 04
Assistante, Delphine Borel • 04 90 74 96 24
- Côte d'Azur - Monaco**
Jérôme Falin • 06 37 62 41 21
Assistante, Stéphanie Imbert • 04 90 74 96 22
- Vaucluse - Ardèche - Cantal - Haute Loire - Drôme**
Delphine Ha • 06 48 79 99 62
Assistante Delphine Borel • 04 90 74 96 24
- Occitanie - Pyrénées - Méditerranée - Aveyron**
Justine Gausson • 06 47 04 59 85
Assistante, Sandrine Sarrazin • 04 90 74 70 45
- Sud-Ouest**
Nicolas Montonen • 07 85 88 19 50
Assistante, Sandrine Sarrazin • 04 90 74 70 45
- Pays de Loire - Poitou**
Sophie Pintiaux • 06 85 23 77 43
Assistante, Stéphanie Imbert • 04 90 74 96 22
- Bretagne - Basse Normandie**
Régis Danais • 06 30 07 35 09
Assistante, Nadège David • 04 90 74 73 60
- Corse**
M. Gabbiati Fabrice • 06 29 31 51 19
Nadège Dauberte • 04 90 74 73 63

BLACHERE ILLUMINATION 2025

GENERAL *catalog*





HEAD OFFICE & WORKSHOP

Blachere Illumination S.A.S
22 Allée des Bourguignons, 84400, Apt
Tel : + 33 (0) 413 068 004
Fax : + 33 (0) 490 741 463

Mail : sales@blachere-illumination.com
Web : blachere-illumination.com

DESIGN • DESIGN DPT BLACHERE

CONTACT

Géraldine - tél : +33 (0) 490 747 323
geraldine@blachere-illumination.com
Léa - tél : +33 (0) 490 747 642
Lalves@blachere-illumination.com
Marion - tél : +33 (0) 490 747 330
marion@blachere-illumination.com
Irène - tél : +33 (0) 490 747 396
i.baravet@blachere-illumination.com
Marie - tél : +33 (0) 490 747 044
marie@blachere-illumination.com
Cathy - tél : +33 (0) 490 747 325
cathy@blachere-illumination.com

COVER • DESIGN DPT BLACHERE

PHOTOGRAPHERS

- Michel Djaoui
- Lionel Moulet
- Jérémie Pitot
- Odile Pascal
- Brice Toul
- Eric Soltan
- Camille Moirenc

PRINT • GROUPE PRENANT

ALL RIGHTS RESERVED

Not a contract document. The sizes and wattages of motifs may be subject to change for technical reasons.
Non-contractual images.

All our products are CE marked meaning that they meet electrical security norms and electromagnetic requirements.
All our motifs, designs and graphics are protected by the INPI, the OMPI and current industrial and intellectual property laws.
Reproduction of any kind, in full or part, is strictly forbidden without written authorisation of blachere illumination s.a.s.

Get inspired at blachere-illumination.com



GOING PAPER FREE

Here at Blachere, above and beyond just being deeply concerned about sustainable development and our carbon footprint, we are constantly looking for ways to increase the efficiency of the tools we use, which has naturally led us towards going paper-free.

Though the «zero paper» business is somewhat of a Utopian ideal, going paper-free considerably reduces the amount of printouts we produce and, as a consequence, our impact on the environment. The paper tools we do continue to use are printed on paper from sustainably managed forests at our «Imprim'vert» accredited printers.

QR Code in our catalogue gives you access to multiple additional media: videos of our decorations and installations, how they look in the daytime, work in progress photos and technical information about the products.

Visit us at www.blachere-illumination.com





Blachere Illumination S.A.S
22 Allée des Bourguignons, 84400, Apt
Tel : + 33 (0) 413 068 004

blachere-illumination.com